

# Table of Contents

## SUNLITE

1. TIRE SAFETY INFORMATION .....	1
<b>1.1. STEPS FOR DETERMINING CORRECT LOAD LIMIT - TRAILER</b> .....	1
<b>1.2. TRAILERS 10,000 POUNDS GVWR OR LESS</b> .....	3
2. TRAILERS OVER 10,000 POUNDS GVWR .....	4
<b>2.1. STEPS FOR DETERMINING CORRECT LOAD LIMIT - TOW VEHICLE</b> .....	4
<b>2.2. GLOSSARY OF TIRE TERMINOLOGY</b> .....	4
<b>2.3 TIRE SAFETY - EVERYTHING RIDES ON IT</b> .....	10
3. SAFETY FIRST - BASIC TIRE MAINTENANCE .....	11
4. FINDING YOUR VEHICLE'S RECOMMENDED TIRE PRESSURE AND LOAD LIMITS .....	12
5. UNDERSTANDING TIRE PRESSURE AND LOAD LIMITS .....	13
6. CHECKING TIRE PRESSURE .....	14
7. STEPS FOR MAINTAINING PROPER TIRE PRESSURE .....	15
8. TIRE SIZE .....	16
9. TIRE TREAD .....	17
10. TIRE BALANCE AND WHEEL ALIGNMENT .....	18
11. TIRE REPAIR .....	19
12. TIRE FUNDAMENTALS .....	20
<b>12.1. INFORMATION ON PASSENGER VEHICLE TIRES</b> .....	20
<b>12.2. UTQGS INFORMATION</b> .....	22
<b>12.3 ADDITIONAL INFORMATION ON LIGHT TRUCK TIRES</b> .....	23
13. TIRE SAFETY TIPS .....	24
<b>13.1. PREVENTING TIRE DAMAGE</b> .....	24
<b>13.2. TIRE SAFETY CHECKLIST</b> .....	24
14. SAFETY INFORMATION .....	25
<b>14.1. SAFETY ALERT SYMBOLS AND SIGNAL WORDS</b> .....	25
<b>14.2. MAJOR HAZARDS</b> .....	26
<b>14.2.1. Driving Too Fast</b> .....	26
<b>14.2.2. Failure to Adjust Handling While Towing a Trailer</b> .....	26
<b>14.2.3. Trailer Not Properly Coupled to the Hitch</b> .....	26
<b>14.2.4. Incorrect Use of Safety Chains</b> .....	27
<b>14.2.5. Incorrect Use of Breakaway Brake</b> .....	27
<b>14.2.6. Mismatch of Trailer and Hitch</b> .....	27
<b>14.2.7. Unsafe Tires, Lug Nuts or Wheels</b> .....	27
<b>14.2.8. Overload</b> .....	29
<b>14.2.9. Unsafe Load Distribution</b> .....	29
<b>14.2.10. Shifting Cargo</b> .....	29
<b>14.2.11. Inappropriate Cargo</b> .....	29

# Table of Contents

## SUNLITE

<b>14.2.12. Inoperable Brakes, Lights or Mirrors</b> .....	30
<b>14.2.13. Hazards From Modifying Your Trailer</b> .....	30
<b>14.2.14. Hazards to Horses (Horse Trailer)</b> .....	30
<b>14.2.15. Hazards to Livestock (Livestock Trailer)</b> .....	31
<b>14.2.16. Hazards from Accessories</b> .....	31
14.2.16.1. Generator .....	31
14.2.16.2. Shore Power .....	31
14.2.16.3. LP Gas Fuel System .....	32
<b>14.2.17. Reporting Safety Defects</b> .....	32
<b>14.2.18. Safety Warning Labels on Your Trailer</b> .....	33
<b>14.2.19. Trailer Towing Guide</b> .....	40
<b>15. COUPLING TO THE TOW VEHICLE</b> .....	42
<b>15.1. USE AN ADEQUATE TOW VEHICLE AND HITCH</b> .....	42
<b>15.1.1. Trailer Information</b> .....	42
<b>15.1.2. Tow Vehicle</b> .....	43
<b>15.2. COUPLING AND UNCOUPLING THE TRAILER</b> .....	45
<b>15.2.1. Trailer with Ball-Hitch Coupler</b> .....	46
15.2.1.1. Before coupling the trailer to the tow vehicle .....	47
15.2.1.2. Prepare the coupler and hitch .....	48
15.2.1.3. Couple the trailer to the tow vehicle .....	49
15.2.1.4. Rig the safety chains .....	49
15.2.1.5. Attach and test electric breakaway brake system .....	50
15.2.1.6. Connect the electrical cables .....	51
15.2.1.7. Uncoupling the Ball Hitch Trailer with Tongue Jack .....	52
<b>15.2.2. Trailer with Gooseneck Coupler and Drop-leg Jack</b> .....	52
15.2.2.1. Prepare the ball receiver and gooseneck ball .....	55
15.2.2.2. Couple the trailer to the tow vehicle .....	56
15.2.2.3. Rig the safety chains .....	57
15.2.2.4. Attach and test the breakaway brake system .....	57
15.2.2.5. Connect the electrical cables .....	59
15.2.2.6. Uncoupling the Gooseneck Trailer with Drop-leg Jack .....	59
<b>15.2.3. Trailer with Fifth-wheel Coupler and Drop-leg Jack</b> .....	61
15.2.3.1. Before attempting to tow the trailer .....	61
15.2.3.2. Attach and test the breakaway brake system .....	64
15.2.3.3. Connect the electrical cables .....	65
15.2.3.4. Uncoupling the Fifth-Wheel Trailer with Drop-leg Jack .....	65
<b>16. LOADING THE TRAILER</b> .....	68
<b>16.1. CHECKING TONGUE WEIGHT</b> .....	69
<b>16.2. SECURING THE CARGO</b> .....	71
<b>16.2.1. Loading Cargo (Enclosed Trailer)</b> .....	71

# Table of Contents

## SUNLITE

16.2.1.1. Loading the Enclosed Trailer .....	72
<b>16.2.2. Loading Horses (Horse Trailer) .....</b>	<b>72</b>
16.2.2.1. Preparing the Horse Trailer for Loading .....	73
16.2.2.2. Loading the Horse Trailer .....	73
<b>16.2.3. Loading Livestock (Livestock Trailer) .....</b>	<b>75</b>
16.2.3.1. Preparing the Livestock Trailer for Loading .....	75
16.2.3.2. Loading the Livestock Trailer .....	77
<b>17. CHECKING THE TRAILER BEFORE AND DURING EACH TOW .....</b>	<b>77</b>
<b>17.1. PRE-TOW CHECKLIST .....</b>	<b>77</b>
<b>17.2. MAKE REGULAR STOPS .....</b>	<b>77</b>
<b>18. BREAKING-IN A NEW TRAILER .....</b>	<b>78</b>
<b>18.1. RETIGHTEN LUG NUTS AT START AND EVERY 50 MILES FOR FIRST 200 MILES ..</b>	<b>78</b>
<b>18.2. ADJUST BRAKE SHOES AT FIRST 200 MILES .....</b>	<b>78</b>
<b>18.3. SYNCHRONIZING THE BRAKE SYSTEMS .....</b>	<b>78</b>
<b>19. ACCESSORIES .....</b>	<b>79</b>
<b>19.1. GASOLINE-POWERED ELECTRIC GENERATORS .....</b>	<b>79</b>
<b>19.2. ACCESSORY BATTERY .....</b>	<b>80</b>
<b>19.3. SHORE POWER .....</b>	<b>80</b>
<b>19.4. LP GAS FUEL SYSTEM .....</b>	<b>81</b>
<b>19.4.1. LP Gas System Troubleshooting .....</b>	<b>82</b>
<b>19.5. ELECTRIC-POWERED LANDING GEAR .....</b>	<b>83</b>
<b>19.6. TRAILER TOP HAYRACKS OR PLATFORMS .....</b>	<b>83</b>
<b>19.7. ELECTRIC/HYDRALIC BRAKE .....</b>	<b>83</b>
<b>20. SUNDOWNER TRAILER WARRANTY .....</b>	<b>84</b>
<b>20.1. FULL 3 YEAR WARRANTY .....</b>	<b>84</b>
<b>20.2. LIMITED 8 YEAR WARRANTY .....</b>	<b>85</b>
<b>20.3. WARRANTY TRANSFER FOR BOTH FULL AND LIMITED WARRANTY: .....</b>	<b>85</b>
<b>20.4. REMEDIES NOT AVAILABLE FROM SUNDOWNER: .....</b>	<b>85</b>
<b>20.5. WHAT WILL VOID THE FULL AND LIMITED WARRANTY: .....</b>	<b>85</b>
<b>20.6. NO OTHER WARRANTIES: .....</b>	<b>85</b>
<b>20.7. IMPORTANT: .....</b>	<b>87</b>
<b>20.8. SERVICE ON SUNDOWNER LIVING QUARTERS .....</b>	<b>87</b>
<b>20.8.1 Procedures .....</b>	<b>88</b>
<b>20.8.2 Parts .....</b>	<b>88</b>
<b>20.8.3 Owner's Responsibility .....</b>	<b>88</b>
<b>20.9 REPORTING SAFETY DEFECTS .....</b>	<b>89</b>

# Table of Contents

## SUNLITE

21. INSPECTION SERVICE & MAINTENANCE .....	90
<b>21.1. INSPECTION, SERVICE &amp; MAINTENANCE SUMMARY CHARTS</b> .....	90
<b>21.2. INSPECTION AND SERVICE INSTRUCTIONS</b> .....	92
<b>21.2.1. Axle Bolts, Frame, Suspension, &amp; Structure</b> .....	92
<b>21.2.2. Trailer Structure</b> .....	93
21.2.2.1. Fasteners and Frame Members .....	93
21.2.2.2. Welds .....	94
<b>21.2.3. Drop Ramp Torsion Springs</b> .....	94
<b>21.2.4. Slide-Outs</b> .....	94
<b>21.2.5. Trailer Brakes</b> .....	94
21.2.5.1. Brake Shoes and Drums .....	94
21.2.5.2. Manually Adjusting Brake Shoes .....	95
21.2.5.3. Brakes, Electric .....	95
<b>21.2.5.3.A. Breakaway Brake</b> .....	95
21.2.5.3.A (I) Breakaway Battery .....	95
21.2.5.3.A (II) Breakaway Switch .....	95
<b>21.2.5.3.B. Tow Vehicle Operated Electric Brakes</b> .....	96
<b>21.2.5.3.C. Magnets for all Electric Brakes</b> .....	96
21.2.5.4. Brakes, Hydraulic (vacuum, air or electric operated) .....	96
<b>21.2.5.4.A Vacuum-Operated Hydraulic</b> .....	96
<b>21.2.5.4.B Air Pressure-Operated Hydraulic</b> .....	97
<b>21.2.5.4.C Electrical-Operated Hydraulic</b> .....	97
<b>21.2.6. Trailer Connection to Tow Vehicle</b> .....	97
21.2.6.1. Coupler and Ball .....	97
21.2.6.2. Gooseneck .....	98
21.2.6.3. Fifth Wheel Kingpin .....	98
<b>21.2.7. Landing Leg or Jack</b> .....	98
<b>21.2.8. Lights and Signals</b> .....	98
<b>21.2.9. Wiring and Lighting Systems</b> .....	99
<b>21.2.10. Accessory Battery</b> .....	100
<b>21.2.11. Tires</b> .....	100
<b>21.2.12. Wheel Rims</b> .....	100
<b>21.2.13. Wheels, Bearings and Lug Nuts</b> .....	101
21.2.13.1. Unsealed Bearings (Hubs) .....	101
<b>21.2.14. Lug Nuts (Bolts)</b> .....	102
<b>21.2.15. Wheel Mounting and Application for Trailer Use</b> .....	102
21.2.15.1. Component Guidelines .....	103
21.2.15.2. Assembly Guidelines .....	103
21.2.15.3. Important Note and Disclaimer .....	105



# LIVING QUARTER PACKAGE

## *Table of Contents*

22. WELCOME TO THE WORLD OF RECREATIONAL VEHICLE OWNERSHIP .....	109
<b>22.1 YOUR FEDERAL CERTIFICATION LABEL</b> .....	109
<b>22.2 ALTERING OR MODIFYING YOUR SUNDOWNER TRAILER CONVERSION</b> ....	109
23. YOUR TOW VEHICLE .....	111
<b>23.1 SPECIAL EQUIPMENT</b> .....	111
<b>23.2 MIRRORS</b> .....	112
<b>23.3 TOWING</b> .....	112
<b>23.4 WHEEL LUGS</b> .....	112
<b>23.5 WHEEL BEARINGS</b> .....	113
<b>23.6 TIRES</b> .....	113
<b>23.7 ELECTRIC BRAKES</b> .....	113
<b>23.8 BREAKAWAY SWITCH</b> .....	114
24. CONNECTING YOUR TRAILER AND TOW VEHICLE .....	115
<b>24.1 A QUICK TRAILERING SHORT COURSE</b> .....	115
<b>24.2 HIGHWAY DRIVING</b> .....	116
25. LOADING YOUR SUNDOWNER TRAILER CONVERSION .....	117
26. SUNDOWNER TRAILER CONVERSION MAINTENANCE .....	118
<b>26.1 TIRE ROTATION</b> .....	118
<b>26.2 WHEEL LUG BOLTS</b> .....	118
<b>26.3 WHEEL BEARINGS</b> .....	118
<b>26.4 BRAKE SERVICE AND MAINTENANCE</b> .....	118
27. OPTIONAL EQUIPMENT FOR CONVENIENCE AND SAFETY .....	120
28. TRAVEL TIPS .....	121
<b>28.1 EQUIPPING YOUR SUNDOWNER TRAILER CONVERSION FOR TRAVEL</b> .....	122
<b>28.2 PACKING</b> .....	122
<b>28.3 EQUIPMENT CHECK LIST</b> .....	122
<b>28.4 HOME SECURITY</b> .....	124
<b>28.5 INSURANCE</b> .....	124
29. SETTING UP YOUR TRAILER .....	125
<b>29.1 PRIMARY SAFETY CONSIDERATIONS</b> .....	125

## Table of Contents

### LIVING QUARTERS

29.1.1 Using Your L.P. Gas System Safely .....	125
29.1.2 Using Your Electrical System Safely .....	126
29.1.3 Emergency Safety .....	126
29.1.4 Additional Safety Tips .....	126
30. WINTER CAMPING .....	127
31. YOUR SYSTEMS .....	129
31.1 ELECTRICAL SYSTEMS .....	129
31.2 CHANGES, MODIFICATIONS AND ADDITIONS .....	129
31.3 12-VOLT D.C. BATTERY SYSTEM .....	129
31.3.1 Battery Care and Maintenance .....	130
31.3.2 Battery Charger .....	130
31.3.3 Care of your Power Converter .....	130
31.3.4 Running, Tall and Stop Lights .....	131
31.3.5 Trouble Shooting Your Living Quarters .....	131
31.4 120-VOLT A.C. SYSTEM .....	132
31.4.1 Connecting to the A.C. Source .....	132
31.4.2 Circuit Breaker Panel .....	134
31.4.3 G.F.C.I. Device .....	134
31.5 L.P. GAS SYSTEM .....	135
31.5.1 Basic Information .....	135
31.5.2 L.P. Gas Bottle Installation Instructions .....	135
31.5.3 L.P. Gas Regulator Installation .....	136
31.5.4 Using the Automatic Changeover Regulator .....	136
31.5.5 Check for Gas Leaks .....	136
31.5.6 Portable Fuel-Burning Equipment .....	137
31.5.7 Storage of Flammable Substances .....	137
31.5.8 L.P. Gas Warning .....	137
31.5.9 Range Ventilation .....	138
31.5.10 L.P. Gas Consumption .....	138
31.5.11 Servicing and Filling L.P. Gas Containers .....	138
32. PLUMBING SYSTEMS .....	140
32.1 FRESH WATER SYSTEM .....	140
32.2 DEMAND SYSTEM .....	140
32.2.1 Operation .....	140
32.3 TROUBLE SHOOTING .....	140
32.3.1 Physical Protection of Water Lines .....	141
32.3.2 Water Conservation .....	141
32.3.3 Handling the Water Supply .....	141
32.3.4 Sanitizing Potable Water Systems .....	141

*Table of Contents*  
**LIVING QUARTERS**

32.3.5 Filling Water Supply Tank .....	142
32.4 CITY WATER SYSTEM .....	142
32.4.1 Draining the Fresh Water System .....	143
32.4.2 Using the Water System During Freezing Weather .....	144
33. SEWAGE AND WATER SYSTEMS .....	145
33.1 DRAIN OUTLET .....	145
33.2 SEWAGE DISPOSAL AND HOLDING TANK CLEANING .....	145
33.3 MARINE TOILET .....	146
33.4 PREPARING DRAINAGE SYSTEM FOR STORAGE OR WINTERIZING .....	146
34. APPLIANCES .....	148
34.1 FURNACE .....	148
34.2 MICROWAVE (OPTIONAL IN SOME UNITS) .....	148
34.3 RANGE .....	148
34.4 REFRIGERATOR .....	149
34.5 WATER HEATER .....	149
35. VEHICLE CARE & GENERAL MAINTENANCE .....	150
35.1 PREVENTATIVE MAINTENANCE GUIDE .....	150
35.2 ROOF VENTS .....	150
35.3 WINDOWS .....	150
35.4 FLOORS .....	150
35.5 EXTERIOR MAINTENANCE .....	151
35.6 TIRES .....	151
35.7 RAIN WATER LEAKS .....	152
35.8 ROOF .....	152
36. APPEARANCE CARE .....	153
36.1 CARE AND CLEANING OF INTERIOR .....	153
36.2 CLEANING GENERAL SOILAGE OR WATER SPOTS FROM FABRIC .....	153
36.3 SPOT CLEANING FABRIC MATERIALS WITH SOLVENT TYPE CLEANER	
36.4 REMOVAL OF SPECIFIC STAINS .....	154
36.4.1 Grease or Oil Stains .....	154
36.4.2 Non-Greasy Stains .....	154
36.5 CLEANING VINYL OR LEATHER .....	155
36.6 GLASS SURFACES .....	155
36.7 COUNTERTOPS, SIDEWALLS, DINETTES AND BATHS .....	155
36.8 INTERIOR FIBERGLASS .....	155
36.9 VINYL FLOOR COVERING .....	155

*Table of Contents*  
**LIVING QUARTERS**

<b>36.10 CARPETING</b> .....	156
<b>36.11 CABINETS</b> .....	156
<b>36.12 INTERIOR LUBRICATION</b> .....	156
<b>36.13 PANELING</b> .....	156
<b>36.14 CUSHION COVERS</b> .....	156
<b>36.15 CONDENSATION</b> .....	157
<b>36.16 STORAGE IN FREEZING CONDITIONS</b> .....	157
<b>36.16.1 Waste System</b> .....	157
<b>36.16.2 Fresh Water System</b> .....	157
<b>36.16.3 Storage Tips in General</b> .....	158







# 1. TIRE SAFETY INFORMATION

---

---

This portion of the User's Manual contains tire safety information as required by 49 CFR 575.6.

Section 2.1 contains "Steps for Determining Correct Load Limit - Trailer".

Section 2.2 contains "Steps for Determining Correct Load Limit Tow Vehicle".

Section 2.3 contains a Glossary of Tire Terminology, including "cold inflation pressure", "maximum inflation pressure", "recommended inflation pressure", and other non-technical terms.

Section 2.4 contains information from the NHTSA brochure entitled "Tire Safety Everything Rides On It".

This brochure, as well as the preceding subsections, describes the following items;

- ◆ **Tire labeling, including a description and explanation of each marking on the tires, and information about the DOT Tire Identification Number (TIN).**
- ◆ **Recommended tire inflation pressure, including a description and explanation of:**

⇒ Cold inflation pressure.

⇒ Vehicle Placard and location on the vehicle.

⇒ Adverse safety consequences of under inflation (including tire failure).

⇒ Measuring and adjusting air pressure for proper inflation.

- ◆ **Tire Care, including maintenance and safety practices.**
- ◆ **Vehicle load limits, including a description and explanation of the following items:**

⇒ Locating and understanding the load limit information, total load capacity, and cargo capacity.

⇒ Calculating total and cargo capacities with varying seating configurations including quantitative examples showing / illustrating how the vehicles cargo and luggage capacity decreases as combined number and size of occupants' increases. This item is also discussed in Section 3.

⇒ Determining compatibility of tire and vehicle load capabilities.

⇒ Adverse safety consequences of overloading on handling and stopping on tires.

## **1.1. STEPS FOR DETERMINING CORRECT LOAD LIMIT TRAILER**

Determining the load limits of a trailer includes more than understanding the load limits of the tires alone. On all trailers there is a Federal certification/VIN label that is located on the forward half of the left (road) side of the unit. This certification/VIN label will indicate the

## Tire Safety Information

---

trailer's Gross Vehicle Weight Rating (GVWR). This is the most weight the fully loaded trailer can weigh. It will also provide the Gross Axle Weight Rating (GAWR). This is the most a particular axle can weigh. If there are multiple axles, the GAWR of each axle will be provided.

If your trailer has a GVWR of 10,000 pounds or less, there is a vehicle placard located in the same location as the certification label described above. This placard provides tire and loading information. In addition, this placard will show a statement regarding maximum cargo capacity. Cargo can be added to the trailer, up to the maximum weight specified on the placard. The combined weight of the cargo is provided as a single number. In any case, remember: the total weight of a fully loaded trailer can not exceed the stated GVWR.

For trailers with living quarters installed, the weight of water and propane also need to be considered. The weight of fully filled propane containers is considered part of the weight of the trailer before it is loaded with cargo, and is not considered part of the disposable cargo load. Water however, is a disposable cargo weight and is treated as such. If there is a fresh water storage tank of 100 gallons, this tank when filled would weigh about 800 pounds. If more cargo is being transported, water can be off-loaded to keep the total amount of cargo added to the vehicle within the limits of the GVWR so as not to overload the vehicle. Understanding this flexibility will allow you, the owner, to make choices that fit your travel needs.

When loading your cargo, be sure it is distributed evenly to prevent overloading front to back and side to side. Heavy items should be placed low and as close to the axle positions as reasonable. Too many items on one side may overload a tire. The best way to know the actual weight of the vehicle is to weigh it at a public scale. Talk to your dealer to discuss the weighing methods needed to capture the various weights related to the trailer. This would include the weight empty or unloaded, weights per axle, wheel, hitch or king-pin, and total weight.

Excessive loads and/or underinflation cause tire overloading and, as a result, abnormal tire flexing occurs. This situation can generate an excessive amount of heat within the tire. Excessive heat may lead to tire failure. It is the air pressure that enables a tire to support the load, so proper inflation is critical. The proper air pressure may be found on the certification/VIN label and/or on the Tire Placard. This value should never exceed the maximum cold inflation pressure stamped on the tire.

## Tire Safety Information

### **1.2 TRAILERS 10,000 POUNDS GVWR OR LESS**

*Tire and Loading Information Placard - Figure 1-1*



**TIRE AND LOADING INFORMATION**

24010118

The weight of cargo should never exceed 907 kg, or 2000 lbs.

TIRE	SIZE	COLD TIRE PRESSURE	<b>SEE OWNER'S MANUAL FOR ADDITIONAL INFORMATION</b>
FRONT	20.5X8.0-10(E)	621kPA or 90SPI	
REAR			
SPARE			

1. Locate the statement, “The weight of cargo should never exceed XXX kg or XXX lbs.,” on your vehicle’s placard. See figure 1-1.
2. This figure equals the available amount of cargo and luggage load capacity.
3. Determine the combined weight of luggage and cargo being loaded on the vehicle. That weight may not safely exceed the available cargo and luggage load capacity.

The trailer’s placard refers to the Tire Information Placard attached adjacent to or near the trailer’s VIN (Certification) label at the left front of the trailer.

## **2. TRAILERS OVER 10,000 POUNDS GVWR**

**(NOTE: THESE TRAILERS ARE NOT REQUIRED TO HAVE A TIRE INFORMATION PLACARD ON THE VEHICLE)**

- ◆ Determine the empty weight of your trailer by weighing the trailer using a public scale or other means. This step does not have to be repeated.
- ◆ Locate the GVWR (Gross Vehicle Weight Rating) of the trailer on your trailer's VIN (Certification) label.
- ◆ Subtract the empty weight of your trailer from the GVWR stated on the VIN label. That weight is the maximum available cargo capacity of the trailer and may not be safely exceeded.

### **2.1. STEPS FOR DETERMINING CORRECT LOAD LIMIT TOW VEHICLE**

- ◆ Locate the statement, "The combined weight of occupants and cargo should never exceed XXX lbs.," on your vehicle's placard.
- ◆ Determine the combined weight of the driver and passengers who will be riding in your vehicle.
- ◆ Subtract the combined weight of the driver and passengers from XXX kilograms or XXX pounds.
- ◆ The resulting figure equals the available amount of cargo and luggage capacity. For example, if the "XXX" amount equals 1400 lbs. and there will be five 150 lb. passengers in your vehicle, the amount of available cargo and luggage capacity is 650 lbs. ( $1400 - 750 (5 \times 150) = 650$  lbs.).
- ◆ Determine the combined weight of luggage and cargo being loaded on the vehicle. That weight may not safely exceed the available cargo and luggage capacity calculated in Step # 4.
- ◆ If your vehicle will be towing a trailer, load from your trailer will be transferred to your vehicle. Consult the tow vehicle's manual to determine how this weight transfer reduces the available cargo and luggage capacity of your vehicle.

### **2.2. GLOSSARY OF TIRE TERMINOLOGY**

#### **Accessory weight**

The combined weight (in excess of those standard items which may be replaced) of automatic transmission, power steering, power brakes, power windows, power seats, radio and heater, to the extent that these items are available as factory-installed equipment (whether installed or not).

#### **Bead**

The part of the tire that is made of steel wires, wrapped or reinforced by ply cords and that is shaped to fit the rim.

#### **Bead separation**

This is the breakdown of the bond between components in the bead.

## Trailers Over 10,000 Pounds GVWR

---

### **Bias ply tire**

A pneumatic tire in which the ply cords that extend to the beads are laid at alternate angles substantially less than 90 degrees to the centerline of the tread.

### **Carcass**

The tire structure, except tread and sidewall rubber which, when inflated, bears the load.

### **Chunking**

The breaking away of pieces of the tread or sidewall.

### **Cold inflation pressure**

The pressure in the tire before you drive.

### **Cord**

The strands forming the plies in the tire.

### **Cord separation**

The parting of cords from adjacent rubber compounds.

### **Cracking**

Any parting within the tread, sidewall, or inner liner of the tire extending to cord material.

### **CT**

A pneumatic tire with an inverted flange tire and rim system in which the rim is designed with rim flanges pointed radially inward and the tire is designed to fit on the underside of the rim in a manner that encloses the rim flanges inside the air cavity of the tire.

### **Curb weight**

The weight of a motor vehicle with standard equipment including the maximum capacity of fuel, oil, and coolant, and, if so equipped, air conditioning and additional weight optional engine.

### **Extra load tire**

A tire designed to operate at higher loads and at higher inflation pressures than the corresponding standard tire.

### **Groove**

The space between two adjacent tread ribs.

### **Gross Axle Weight Rating**

The maximum weight that any axle can support, as published on the Certification / VIN label on the front left side of the trailer. Actual weight determined by weighing each axle on a public scale, with the trailer attached to the towing vehicle.

---

## Trailers Over 10,000 Pounds GVWR

---

### **Gross Vehicle Weight Rating**

The maximum weight of the fully loaded trailer, as published on the Certification / VIN label. Actual weight determined by weighing trailer on a public scale, without being attached to the towing vehicle.

### **Hitch Weight**

The downward force exerted on the hitch ball by the trailer coupler.

### **Innerliner**

The layer(s) forming the inside surface of a tubeless tire that contains the inflating medium within the tire.

### **Innerliner separation**

The parting of the innerliner from cord material in the carcass.

### **Intended outboard sidewall**

The sidewall that contains a white-wall, bears white lettering or bears manufacturer, brand, and/or model name molding that is higher or deeper than the same molding on the other sidewall of the tire or the outward facing sidewall of an asymmetrical tire that has a particular side that must always face outward when mounted on a vehicle.

### **Light truck (LT) tire**

A tire designated by its manufacturer as primarily intended for use on lightweight trucks or multipurpose passenger vehicles.

### **Load rating**

The maximum load that a tire is rated to carry for a given inflation pressure.

### **Maximum load rating**

The load rating for a tire at the maximum permissible inflation pressure for that tire.

### **Maximum permissible inflation pressure**

The maximum cold inflation pressure to which a tire may be inflated.

### **Maximum loaded vehicle weight**

The sum of curb weight, accessory weight, vehicle capacity weight, and production options weight.

### **Measuring rim**

The rim on which a tire is fitted for physical dimension requirements.

### **Pin Weight**

The downward force applied to the 5<sup>th</sup> wheel or gooseneck ball, by the trailer kingpin or gooseneck coupler.



**Non-pneumatic rim**

A mechanical device which, when a non-pneumatic tire assembly incorporates a wheel, supports the tire, and attaches, either integrally or separably, to the wheel center member and upon which the tire is attached.

**Non-pneumatic spare tire assembly**

A non-pneumatic tire assembly intended for temporary use in place of one of the pneumatic tires and rims that are fitted to a passenger car in compliance with the requirements of this standard.

**Non-pneumatic tire**

A mechanical device which transmits, either directly or through a wheel or wheel center member, the vertical load and tractive forces from the roadway to the vehicle, generates the tractive forces that provide the directional control of the vehicle and does not rely on the containment of any gas or fluid for providing those functions.

**Non-pneumatic tire assembly**

A non-pneumatic tire, alone or in combination with a wheel or wheel center member, which can be mounted on a vehicle.

**Normal occupant weight**

This means 68 kilograms (150 lbs.) times the number of occupants specified in the second column of Table I of 49 CFR 571.110.

**Occupant distribution**

The distribution of occupants in a vehicle as specified in the third column of Table I of 49 CFR 571.110.

**Open splice**

Any parting at any junction of tread, sidewall, or innerliner that extends to cord material.

**Outer diameter**

The overall diameter of an inflated new tire.

**Overall width**

The linear distance between the exteriors of the sidewalls of an inflated tire, including elevations due to labeling, decorations, or protective bands or ribs.

**Ply**

A layer of rubber-coated parallel cords.

**Ply separation**

A parting of rubber compound between adjacent plies.

**Pneumatic tire**

## Trailers Over 10,000 Pounds GVWR

---

A mechanical device made of rubber, chemicals, fabric and steel or other materials, that, when mounted on an automotive wheel, provides the traction and contains the gas or fluid that sustains the load.

### **Production options weight**

The combined weight of those installed regular production options weighing over 2.3 kilograms (5 lbs.) in excess of those standard items which they replace, not previously considered in curb weight or accessory weight, including heavy duty brakes, ride levelers, roof rack, heavy duty battery, and special trim.

### **Radial ply tire**

A pneumatic tire in which the ply cords that extend to the beads are laid at substantially 90 degrees to the centerline of the tread.

### **Recommended inflation pressure**

This is the inflation pressure provided by the vehicle manufacturer on the Tire Information label and on the Certification / VIN tag.

### **Reinforced tire**

A tire designed to operate at higher loads and at higher inflation pressures than the corresponding standard tire.

### **Rim**

A metal support for a tire or a tire and tube assembly upon which the tire beads are seated.

### **Rim diameter**

This means the nominal diameter of the bead seat.

### **Rim size designation**

This means the rim diameter and width.

### **Rim type designation**

This means the industry of manufacturer's designation for a rim by style or code.

### **Rim width**

This means the nominal distance between rim flanges.

### **Section width**

The linear distance between the exteriors of the sidewalls of an inflated tire, excluding elevations due to labeling, decoration, or protective bands.

### **Sidewall**

That portion of a tire between the tread and bead.

### **Sidewall separation**

## Trailers Over 10,000 Pounds GVWR

---

The parting of the rubber compound from the cord material in the sidewall.

### **Special Trailer (ST) tire**

The “ST” is an indication the tire is for trailer use only.

### **Test rim**

The rim on which a tire is fitted for testing, and may be any rim listed as appropriate for use with that tire.

### **Tread**

That portion of a tire that comes into contact with the road.

### **Tread rib**

A tread section running circumferentially around a tire.

### **Tread separation**

Pulling away of the tread from the tire carcass.

### **Treadwear indicators (TWI)**

The projections within the principal grooves designed to give a visual indication of the degrees of wear of the tread.

### **Vehicle capacity weight**

The rated cargo and luggage load plus 68 kilograms (150 lbs.) times the vehicle’s designated seating capacity.

### **Vehicle maximum load on the tire**

The load on an individual tire that is determined by distributing to each axle its share of the maximum loaded vehicle weight and dividing by two.

### **Vehicle normal load on the tire**

The load on an individual tire that is determined by distributing to each axle its share of the curb weight, accessory weight, and normal occupant weight (distributed in accordance with Table I of CRF 49 571.110) and dividing by 2.

### **Weather side**

The surface area of the rim not covered by the inflated tire.

### **Wheel center member**

In the case of a non-pneumatic tire assembly incorporating a wheel, a mechanical device which attaches, either integrally or separably, to the non-pneumatic rim and provides the connection between the non-pneumatic rim and the vehicle; or, in the case of a non-pneumatic tire assembly not incorporating a wheel, a mechanical device which attaches, either integrally or separably, to the non-pneumatic tire and provides the connection between tire and the vehicle.

**Wheel-holding fixture**

The fixture used to hold the wheel and tire assembly securely during testing.

**2.3. TIRE SAFETY - EVERYTHING RIDES ON IT**

The National Traffic Safety Administration (NHTSA) has published a brochure (DOT HS 809 361) that discusses all aspects of Tire Safety, as required by CFR 575.6. This brochure is reproduced in part below. It can be obtained and downloaded from NHTSA, free of charge, from the following web site:

[http://www.nhtsa.dot.gov/cars/rules/TireSafety/ridesonit/tires\\_index.html](http://www.nhtsa.dot.gov/cars/rules/TireSafety/ridesonit/tires_index.html)

Studies of tire safety show that maintaining proper tire pressure, observing tire and vehicle load limits (not carrying more weight in your vehicle than your tires or vehicle can safely handle), avoiding road hazards, and inspecting tires for cuts, slashes, and other irregularities are the most important things you can do to avoid tire failure, such as tread separation or blowout and flat tires. These actions, along with other care and maintenance activities, can also:

- ⇒ Improve vehicle handling
- ⇒ Help protect you and others from avoidable breakdowns and accidents
- ⇒ Improve fuel economy
- ⇒ Increase the life of your tires.

This booklet presents a comprehensive overview of tire safety, including information on the following topics:

- ⇒ Basic tire maintenance
- ⇒ Uniform Tire Quality Grading System
- ⇒ Fundamental characteristics of tires
- ⇒ Tire safety tips.

Use this information to make tire safety a regular part of your vehicle maintenance routine. Recognize that the time you spend is minimal compared with the inconvenience and safety consequences of a flat tire or other tire failure.

### **3. SAFETY FIRST BASIC TIRE MAINTENANCE**

---

Properly maintained tires improve the steering, stopping, traction, and load-carrying capability of your vehicle.

Underinflated tires and overloaded vehicles are a major cause of tire failure. Therefore, as mentioned above, to avoid flat tires and other types of tire failure, you should maintain proper tire pressure, observe tire and vehicle load limits, avoid road hazards, and regularly inspect your tires.

Be sure to check the speed rating on sidewall of tires. Some tires, can be rated by the tire manufacturer, at lower speeds, than legally posted speed limits. **KNOW WHAT YOUR SPECIFIC TIRE SPEED RATING IS**; running higher than the rated speed can cause damage to the tire, possibly resulting in a blow-out, loss of vehicle control, and personal injury. Be sure to check the tire pressure often (before each trip) and do not exceed the maximum rated speed.

## **4. FINDING YOUR VEHICLE'S RECOMMENDED TIRE PRESSURE AND LOAD LIMITS**

---

Tire information placards and vehicle certification labels contain information on tires and load limits. These labels indicate the vehicle manufacturer's information including:

- ◆ Recommended tire size
- ◆ Recommended tire inflation pressure
- ◆ Vehicle capacity weight (VCW the maximum occupant and cargo weight a vehicle is designed to carry)
- ◆ Front and rear gross axle weight ratings (GAWR the maximum weight the axle systems are designed to carry).

Both placards and certification labels are permanently attached to the trailer near the left front.

## 5. UNDERSTANDING TIRE PRESSURE AND LOAD LIMITS

---

---

Tire inflation pressure is the level of air in the tire that provides it with load-carrying capacity and affects the overall performance of the vehicle. The tire inflation pressure is a number that indicates the amount of air pressure measured in pounds per square inch (psi) a tire requires to be properly inflated. (You will also find this number on the vehicle information placard expressed in kilopascals (kPa), which is the metric measure used internationally.)

Manufacturers of passenger vehicles and light trucks determine this number based on the vehicle's design load limit, that is, the greatest amount of weight a vehicle can safely carry and the vehicle's tire size. The proper tire pressure for your vehicle is referred to as the "recommended cold inflation pressure." (As you will read below, it is difficult to obtain the recommended tire pressure if your tires are not cold.)

Because tires are designed to be used on more than one type of vehicle, tire manufacturers list the "maximum permissible inflation pressure" on the tire sidewall. This number is the greatest amount of air pressure that should ever be put in the tire under normal driving conditions.

## 6. CHECKING TIRE PRESSURE

---

---

It is important to check your vehicle's tire pressure at least once a month for the following reasons:

- ◆ Most tires may naturally lose air over time.
- ◆ Tires can lose air suddenly if you drive over a pothole or other object or if you strike the curb when parking.
- ◆ With radial tires, it is usually not possible to determine underinflation by visual inspection.

For convenience, purchase a tire pressure gauge to keep in your vehicle. Gauges can be purchased at tire dealerships, auto supply stores, and other retail outlets.

The recommended tire inflation pressure that vehicle manufacturers provide reflects the proper psi when a tire is cold. The term cold does not relate to the outside temperature. Rather, a cold tire is one that has not been driven on for at least three hours. When you drive, your tires get warmer, causing the air pressure within them to increase. Therefore, to get an accurate tire pressure reading, you must measure tire pressure when the tires are cold or compensate for the extra pressure in warm tires.



## 7. STEPS FOR MAINTAINING PROPER TIRE-PRESSURE

---

- ◆ Step 1: Locate the recommended tire pressure on the vehicle's tire information placard, certification label, or in the owner's manual.
- ◆ Step 2: Record the tire pressure of all tires.
- ◆ Step 3: If the tire pressure is too high in any of the tires, slowly release air by gently pressing on the tire valve stem with the edge of your tire gauge until you get to the correct pressure.
- ◆ Step 4: If the tire pressure is too low, note the difference between the measured tire pressure and the correct tire pressure. These "missing" pounds of pressure are what you will need to add.
- ◆ Step 5: At a service station, add the missing pounds of air pressure to each tire that is underinflated.
- ◆ Step 6: Check all the tires to make sure they have the same air pressure (except in cases in which the front and rear tires are supposed to have different amounts of pressure).

If you have been driving your vehicle and think that a tire is underinflated, fill it to the recommended cold inflation pressure indicated on your vehicle's tire information placard or certification label. While your tire may still be slightly underinflated due to the extra pounds of pressure in the warm tire, it is safer to drive with air pressure that is slightly lower than the vehicle manufacturer's recommended cold inflation pressure than to drive with a significantly underinflated tire. Since this is a temporary fix, don't forget to recheck and adjust the tire's pressure when you can obtain a cold reading.

## **8. TIRE SIZE**

---

---

To maintain tire safety, purchase new tires that are the same size as the vehicle's original tires or another size recommended by the manufacturer. Look at the tire information placard, the owner's manual, or the sidewall of the tire you are replacing to find this information. If you have any doubt about the correct size to choose, consult with the tire dealer.

## 9. TIRE TREAD

---

---

The tire tread provides the gripping action and traction that prevent your vehicle from slipping or sliding, especially when the road is wet or icy.

In general, tires are not safe and should be replaced when the tread is worn down to 1/16 of an inch. Tires have built-in treadwear indicators that let you know when it is time to replace your tires. These indicators are raised sections spaced intermittently in the bottom of the tread grooves. When they appear “even” with the outside of the tread, it is time to replace your tires.

Another method for checking tread depth is to place a penny in the tread with Lincoln’s head upside down and facing you. If you can see the top of Lincoln’s head, you are ready for new tires.

## **10. TIRE BALANCE AND WHEEL ALIGNMENT**

---

---

To avoid vibration or shaking of the vehicle when a tire rotates, the tire must be properly balanced. This balance is achieved by positioning weights on the wheel to counterbalance heavy spots on the wheel-and-tire assembly. A wheel alignment adjusts the angles of the wheels so that they are positioned correctly relative to the vehicle's frame. This adjustment maximizes the life of your tires. These adjustments require special equipment and should be performed by a qualified technician.

## **11. TIRE REPAIR**

---

---

The proper repair of a punctured tire requires a plug for the hole and a patch for the area inside the tire that surrounds the puncture hole. Punctures through the tread can be repaired if they are not too large, but punctures to the sidewall should not be repaired. Tires must be removed from the rim to be properly inspected before being plugged and patched.

# 12. TIRE FUNDAMENTALS

Federal law requires tire manufacturers to place standardized information on the sidewall of all tires. This information identifies and describes the fundamental characteristics of the tire and also provides a tire identification number for safety standard certification and in case of a recall.

## 12.1. INFORMATION ON PASSENGER VEHICLE TIRES

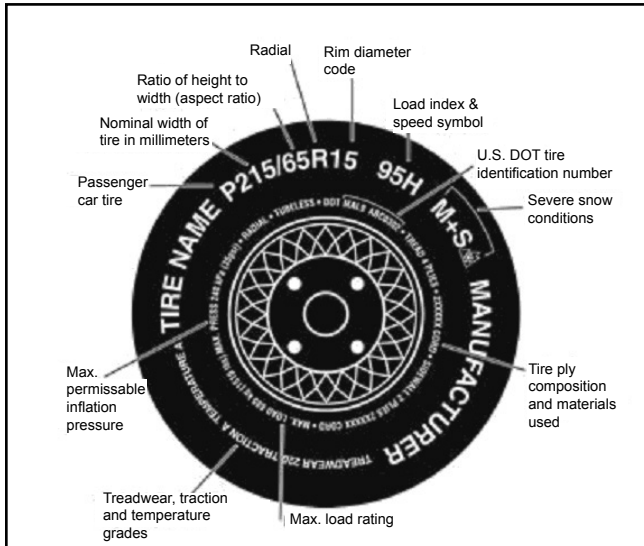

**P**  
The “P” indicates the tire is for passenger vehicles.

### Next number

This three-digit number gives the width in millimeters of the tire from sidewall edge to sidewall edge. In general, the larger the number, the wider the tire.

### Next number

This two-digit number, known as the aspect ratio, gives the tire’s ratio of height to width. Numbers of 70 or lower indicate a short sidewall for improved steering response and better overall handling on dry pavement.

### R

The “R” stands for radial. Radial ply construction of tires has been the industry standard for the past 20 years.

## Tire Fundamentals

---

### **Next number**

This two-digit number is the wheel or rim diameter in inches. If you change your wheel size, you will have to purchase new tires to match the new wheel diameter.

### **Next number**

This two- or three-digit number is the tire's load index. It is a measurement of how much weight each tire can support. You may find this information in your owner's manual. If not, contact a local tire dealer. Note: You may not find this information on all tires because it is not required by law.

### **M+S**

The "M+S" or "M/S" indicates that the tire has some mud and snow capability. Most radial tires have these markings; hence, they have some mud and snow capability.

### **Speed Rating**

The speed rating denotes the speed at which a tire is designed to be driven for extended periods of time.

### **U.S. DOT Tire Identification Number**

This begins with the letters "DOT" and indicates that the tire meets all federal standards. The next two numbers or letters are the plant code where it was manufactured, and the last four numbers represent the week and year the tire was built. For example, the numbers 3197 means the 31st week of 1997. The other numbers are marketing codes used at the manufacturer's discretion. This information is used to contact consumers if a tire defect requires a recall.

### **Tire Ply Composition and Materials Used**

---

## Tire Fundamentals

---

The number of plies indicates the number of layers of rubber-coated fabric in the tire. In general, the greater the number of plies, the more weight a tire can support. Tire manufacturers also must indicate the materials in the tire, which include steel, nylon, polyester, and others.

### **Maximum Load Rating**

This number indicates the maximum load in kilograms and pounds that can be carried by the tire.

### **Maximum Permissible Inflation Pressure**

This number is the greatest amount of air pressure that should ever be put in the tire under normal driving conditions.

## **12.2. UTQGS INFORMATION**

### **Treadwear Number**

This number indicates the tire's wear rate. The higher the treadwear number is, the longer it should take for the tread to wear down. For example, a tire graded 400 should last twice as long as a tire graded 200.

### **Traction Letter**

This letter indicates a tire's ability to stop on wet pavement. A higher graded tire should allow you to stop your car on wet roads in a shorter distance than a tire with a lower grade. Traction is graded from highest to lowest as "AA," "A," "B," and "C".

### **Temperature Letter**

This letter indicates a tire's resistance to heat. The temperature grade is for a tire that is inflated properly and not overloaded. Excessive speed, underinflation or excessive loading, either separately or in combination, can cause heat build-up and possible tire failure. From highest to lowest, a tire's resistance to heat is graded as "A," "B," or "C".



### **12.3. ADDITIONAL INFORMATION ON LIGHT TRUCK TIRES**

Please refer to the following diagram.

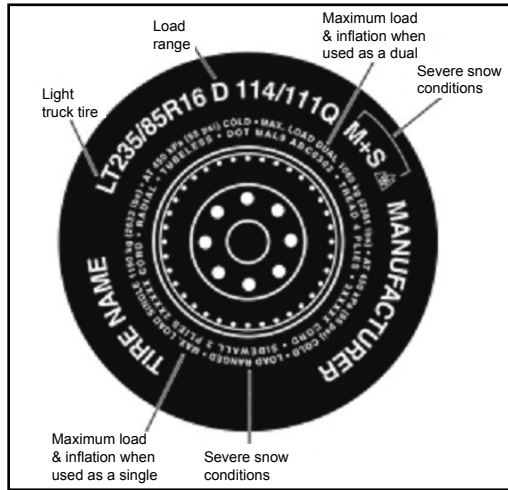

Tires for light trucks have other markings besides those found on the sidewalls of passenger tires.

#### **LT**

The “LT” indicates the tire is for light trucks or trailers.

#### **ST**

An “ST” is an indication the tire is for trailer use only.

#### **Max. Load Dual kg (lbs) at kPa (psi) Cold**

This information indicates the maximum load and tire pressure when the tire is used as a dual, that is, when four tires are put on each rear axle (a total of six or more tires on the vehicle).

#### **Max. Load Single kg (lbs) at kPa (psi) Cold**

This information indicates the maximum load and tire pressure when the tire is used as a single.

#### **Load Range**

This information identifies the tire’s load-carrying capabilities and its inflation limits.

# 13. TIRE SAFETY TIPS

---

## **13.1. PREVENTING TIRE DAMAGE**

- ◆ Slow down if you have to go over a pothole or other object in the road.
- ◆ Do not run over curbs or other foreign objects in the roadway, and try not to strike the curb when parking.

## **13.2. TIRE SAFETY CHECKLIST**

- ◆ Check tire pressure regularly (at least once a month), including the spare.
- ◆ Inspect tires for uneven wear patterns on the tread, cracks, foreign objects, or other signs of wear or trauma.
- ◆ Remove bits of glass and foreign objects wedged in the tread.
- ◆ Make sure your tire valves have valve caps.
- ◆ Check tire pressure before going on a long trip.
- ◆ Do not overload your vehicle. Check the Tire Information and Loading Placard or User's Manual for the maximum recommended load for the vehicle.

# 14. SAFETY INFORMATION

## 14.1. SAFETY ALERT SYMBOLS AND SIGNAL WORDS

Loss of control of the trailer or trailer/tow vehicle combination can result in death or serious injury. The most common causes for loss of control of the trailer are:

- ◆ **Driving too fast for the conditions (maximum speed when towing a trailer is 60 m.p.h.);**
- ◆ **Overloading the trailer or loading the trailer unevenly;**
- ◆ **Trailer improperly coupled to the hitch;**
- ◆ **Inadequate tow vehicle or towing hitch;**
- ◆ **No braking on trailer;**
- ◆ **Not maintaining proper tire pressure;**
- ◆ **Not keeping lug nuts tight; and**
- ◆ **Not properly maintaining the trailer structure.**

An owner's manual that provides general trailer information cannot cover all of the specific details necessary for the proper combination of every trailer, tow vehicle and hitch. Therefore, you must read, understand and follow the instructions given by the tow vehicle and trailer hitch manufacturers, as well as the instructions in this manual.

### Trailer Components

Our trailers are built with components produced by various manufacturers, therefore, some of these items have separate instructions manuals. Where this manual indicates that you should read another manual, and you do not have that manual, call Sundowner Trailers, Inc. at (800) 654-3897 for a free copy.

The safety information in this manual is denoted by the safety alert symbol:  The level of risk is indicated by the following signal words.

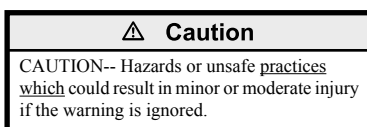
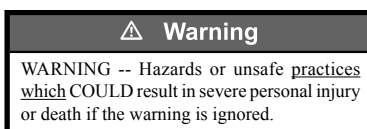
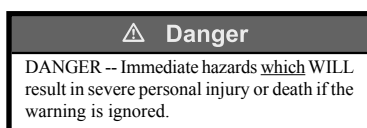

## Safety Information

---

### Notice

NOTICE -- Practices that could result in damage to the trailer or other property.

## **14.2 MAJOR HAZARDS**

### **14.2.1. Driving Too Fast**

With ideal road conditions, the maximum speed when safely towing a trailer is 60 m.p.h. If you drive too fast, the trailer tires will overheat and possibly blowout. As your speed increases, you are more likely to suddenly lose control. Never exceed 60 m.p.h. while towing the trailer.

### Warning

Driving too fast for conditions can result in loss of control and cause death or serious injury.

Decrease your speed as road, weather and lighting conditions deteriorate.

### **14.2.2. Failure to Adjust Handling While Towing a Trailer**

When towing a trailer, you will have decreased acceleration, increased stopping distance, and increased turning radius (which means you must make wider turns to keep from hitting curbs, vehicles, and anything else that is on the inside corner). In addition, you will need a longer distance to pass, due to slower acceleration and increased length.

- ◆ Be alert for slippery conditions. You are more likely to be affected by slippery road surfaces when driving a tow vehicle with a trailer, than driving a tow vehicle without a trailer.
- ◆ Anticipate the trailer “swaying.” Swaying is the trailers reaction to the air pressure wave caused by passing trucks and busses. Continued pulling of the trailer provides a stabilizing force to correct swaying. Do not apply the brakes to correct trailer swaying.
- ◆ Check rearview mirrors frequently to observe the trailer and traffic.
- ◆ Use a lower gear when driving down steep or long grades. Use the engine and transmission as a brake. Do not ride the brakes, as they can overheat and become ineffective.
- ◆ Be aware of your trailer height, especially when approaching roofed areas and when around trees.

### **14.2.3. Trailer Not Properly Coupled to the Hitch**

It is critical that the trailer be securely coupled to the hitch, and that the safety chains are correctly attached. Uncoupling may result in death or serious injury.

### **Warning**

Proper selection and condition of the coupler and hitch are essential to safely towing your trailer. A loss of coupling may result in death or serious injury.

- Be sure the hitch load rating is equal to or greater than the load rating of the coupler.
- Be sure the hitch size matches the coupler size
- Observe the hitch for wear, corrosion and cracks before coupling. Replace worn, corroded or cracked hitch components before coupling the trailer to the tow vehicle.
- Be sure the hitch components are tight before coupling the trailer to the tow vehicle.

#### **14.2.4. Incorrect Use of Safety Chains**

If your trailer comes loose from the hitch for any reason, we have provided safety chains so that control of the trailer can still be maintained.

#### **14.2.5. Incorrect Use of Breakaway Brake**

Your trailer may also be equipped with a breakaway brake system that can apply the brakes on your trailer if your trailer comes loose from the hitch for any reason. The safety chains and breakaway brake system must be in good condition and properly rigged to be effective. NOTE: The breakaway system is not designed to be utilized as a parking brake. When uncoupling from trailer use wheel chocks.

#### **14.2.6. Mismatch of Trailer and Hitch**

### **Danger**

Use of hitch with a load rating less than the load rating of the trailer can result in loss of control and may lead to death or serious injury.

Use of a tow vehicle with a towing capacity less than the load rating of the trailer can result in loss of control, and may lead to death or serious injury.

Be sure your hitch and tow vehicle are rated for the Gross Vehicle Weight Rating (GVWR) of your trailer.

Make sure that hitch ball and coupler are the same size.

#### **14.2.7. Unsafe Tires, Lug Nuts or Wheels**

Trailer tires and wheels are more likely to fail than car tires and wheels because they carry a heavier load. Therefore, it's essential to inspect the trailer tires before each tow.

## Safety Information

---

If a tire has bald spots, bulge, cuts, is showing any cords, or is cracked, replace the tire before towing. If a tire has uneven tread wear, take the trailer to a dealer service center for diagnosis. Uneven tread wear can be caused by tire imbalance, axle misalignment or incorrect inflation.

Tires with too little tread will not provide adequate tracking on wet roadways and can result in loss of control, leading to death or serious injury.

Improper tire pressure causes an unstable trailer and can result in a tire blowout and loss of control. Therefore, before each tow you must also check the tire pressure while the tires are cold. Allow 3 hours cool-down after driving as much as 1 mile at 40 m.p.h. before checking tire pressure. NOTE: Trailer tires will be inflated to higher pressures than passenger vehicle tires.

 <b>Warning</b>
Improper tire pressure can result in a blowout and loss of control, which can lead to death or serious injury.
Be sure tires are inflated to pressure indicated on sidewall before towing trailer.

Since trailer wheels and lug nuts (or bolts) are subjected to greater side loads than automobile wheels, they are more prone to loosen. Before each tow, check to make sure they are tight.

The proper tightness (torque) for lug nuts is listed at page 100 in the “Inspection and Service Instructions” chapter of this manual. Use a torque wrench to tighten the lug nuts. If you do not have a torque wrench, use a lug wrench (from your tow vehicle) and tighten the nuts as much as you can. Then have a service garage or trailer dealer tighten the lug nuts to the proper torque.

Lug nuts are also prone to loosen after first being assembled. When pulling a new trailer (or after wheels have been remounted), check to make sure they are tight at start and every 50 miles for first 200 miles and before each tow thereafter.

Failure to perform this check can result in a wheel parting from the trailer and a crash, leading to death or serious injury.

 <b>Warning</b>
Lug nuts are prone to loosen after initial installation, which can lead to death or serious injury.
Check lug nuts for tightness on a new trailer or when wheel(s) have been remounted at start and every 50 miles for first 200 miles.
Improper lug nut torque can cause a wheel parting from the trailer, leading to death or serious injury.
Be sure lug nuts are tight before each tow.

### **14.2.8. Overload**

The total weight of the load you put in or on the trailer, plus the empty weight of the trailer itself, must not exceed the trailer's Gross Vehicle Weight Rating (GVWR). If you do not know the empty weight of the trailer, you can weigh it at a commercial scale. In addition, you must distribute the load in the trailer such that the load on any tire or axle does not exceed the tire load rating or the Gross Axle Weight Rating (GAWR).

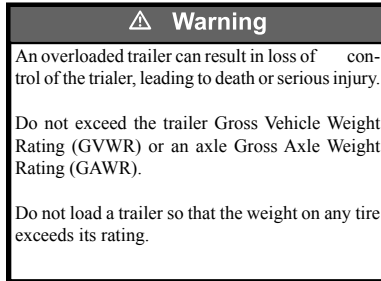

### **14.2.9. Unsafe Load Distribution**

Uneven load distribution can cause tire, wheel, axle or structural failure. Be sure your trailer is properly loaded.

A proper weight distribution is equal, right to left; and does not create a negative tongue weight.

Towing stability also depends on keeping the center of gravity as low as possible. Load heavy items on the floor and over the axles, but do not exceed the axle load rating (GAWR). When loading additional items be sure to maintain even side-to-side weight distribution and proper tongue weight.

### **14.2.10. Shifting Cargo**

Since the trailer "ride" can be bumpy and rough, you must secure your cargo so that it does not shift while the trailer is being towed.

If the door latch is equipped with a catch that has a hole for a linchpin, use a linchpin to prevent the door latch from opening.

### **14.2.11. Inappropriate Cargo**

Your trailer may be designed for specific cargo, for example, only for horses. If your trailer is designed for specific cargo, only carry that cargo in the trailer. A utility trailer must not be used to carry certain items, such as people, containers of hazardous substances or containers of flammable substances.

### **14.2.12. Inoperable Brakes, Lights or Mirrors**

Be sure that the electric brakes and all of the lights on your trailer are functioning properly before towing your trailer. Electric brakes and lights on a trailer are controlled via a connection to the tow vehicle, generally a multi-pin electrical connector. If the wire harness on the tow vehicle is not factory installed, make sure the ground wire is connected to the battery's negative terminal. Check the trailer tail lights by turning on your tow vehicle headlights. Check the trailer brake lights by having someone step on the tow vehicle brake pedal while you look at trailer lights. Do the same thing to check the turn signal lights.

If your trailer has electric brakes, your tow vehicle needs an electric brake controller that sends power to the trailer brakes. Before towing the trailer on the road, you must operate the brake controller while trying to pull the trailer in order to confirm that the electric brakes operate. While towing the trailer at less than 5 m.p.h., manually operate the electric brake controller in the tow vehicle cab. You should feel the operation of the trailer brakes.

Standard mirrors usually do not provide adequate visibility for viewing traffic to the sides and rear of a towed trailer. You must provide mirrors that allow you to safely observe approaching traffic.

### **14.2.13. Hazards From Modifying Your Trailer**

A wide variety of non Sundowner modifications and parts are available in the market. Sundowner DOES NOT warranty these parts or modifications and is not responsible for their performance, repair or replacement, or for any damage they may cause to, or adverse effect they may have on your Sundowner trailer.

Non-Sundowner approved parts or modifications could affect the trailers performance, safety or durability, and may even violate governmental regulations.

Essential safety items can be damaged by altering your trailer. Even simply driving a nail or screw to hang something can damage an electrical circuit, LP gas line or other feature of the trailer.

Before making any alteration to your trailer, contact your dealer or Sundowner Trailers, Inc. at (800) 654-3879 and describe the alteration you are contemplating. Alteration of the trailer structure or modification of mechanical, electrical, plumbing, heating or other systems on your trailer must be performed only by qualified technicians who are familiar with the system installed on your trailer.

### **14.2.14. Hazards to Horses (Horse Trailer)**

Before hauling a horse, you must be aware of its temperament.



## Safety Information

---

The layout of a horse trailer is designed to safely contain your horse. If the trailer is equipped with stall dividers and tie rings to secure the horse, use of both is recommended to ensure optimum safety.

Before loading your horse, inspect the interior of the horse trailer to insure that no hazards are present. Read section 3.2.2. on “Loading the Horse Trailer” page 47 of this manual for specific instructions regarding trailering of horses.

### **14.2.15. Hazards to Livestock (Livestock Trailer)**

A livestock trailer is designed for the safe transport of livestock, other than horses. It is not equipped for hauling horses.

Before loading your livestock, inspect the interior of the livestock trailer to insure that no hazards are present. Read section 3.2.3, page 49 “Loading Livestock (Livestock Trailer)” for specific instructions regarding trailering of livestock other than horses.

### **14.2.16. Hazards from Accessories**

The “Accessories” chapter of this manual contains some information about certain optional accessories that may be on your trailer. Read and follow all of these instructions before operating the accessories. The major hazards from some of these accessories are:

#### **14.2.16.1. Generator**

If your trailer is equipped with a gasoline or diesel generator, you must have and follow the generator manufacturer’s instructions. You must also have one or more carbon monoxide detectors in the trailer’s accommodation spaces.

Carbon Monoxide is an odorless gas that can cause death. Be certain exhaust from a running generator does not accumulate in or around your trailer, by situations such as:

- ◆ Being drawn in by fans or ventilators operated in a trailer;
- ◆ Prevailing wind;
- ◆ Being trapped between your trailer and other trailers, vehicles or buildings; or
- ◆ Being trapped between your trailer and or in a snow bank, or other nearby objects

#### **14.2.16.2. Shore Power**

“Shore Power” is the name given to connecting your trailer to a source of electrical power using an extension cord specifically designed for that purpose.

## Safety Information

---

### 14.2.16.3. LP Gas Fuel System

 <b>Warning</b>
Only connect an LP gas system to a supply of LP gas, NOT natural gas. Do not store LP gas tanks inside the trailer. Only fill an LP gas tank 80% full. Only fill the tank with LP gas (butane or propane). Overfilled tanks can release gas and cause an explosion.
<b>Risk of fire or explosion</b> If LP gas is detected (by smell or by the LP gas detector): <ul style="list-style-type: none"><li>· Do not touch electrical switches</li><li>· Extinguish flames and pilot lights</li><li>· Open doors for ventilation</li><li>· Shut off LP gas supply at the LP tank</li><li>· Leave the area until odor clears</li></ul> Correct the source of LP gas leakage before using LP appliances. Do not use a flame to locate the source of an LP gas leak.
<b>Risk of fire or explosion</b> Never use a flame, heat lamp or hair dryer to thaw an LP gas regulator. Use an incandescent light bulb. Do not remove the regulator cover or attempt to service the LP gas regulator.

### 14.2.17. Reporting Safety Defects

If you believe that your vehicle has a defect that could cause a crash or could cause injury or death, you should immediately inform the National Highway Traffic Safety Administration, (NHTSA) in addition to notifying Sundowner Trailers Inc.

If NHTSA receives similar complaints, it may open an investigation, and if it finds that a safety defect exists in a group of vehicles, it may order a recall and remedy campaign. However, NHTSA cannot become involved in individual problems between you, your dealer, or Sundowner Trailers Inc.

To contact NHTSA, you may either call the Vehicle Safety Hotline toll-free at 1-888-327-4236 (TTY: 1-800-424-9133), go to <http://www.safercar.gov>; or write to:

Administrator  
NHTSA  
1200 New Jersey Avenue S.E.  
Washington, DC 20390

You can also obtain other information about motor vehicle safety from <http://www.safercar.gov>.

**14.2.18. Safety Warning Labels on Your Trailer**

*Figure 1-1 Warning Labels and Locations*

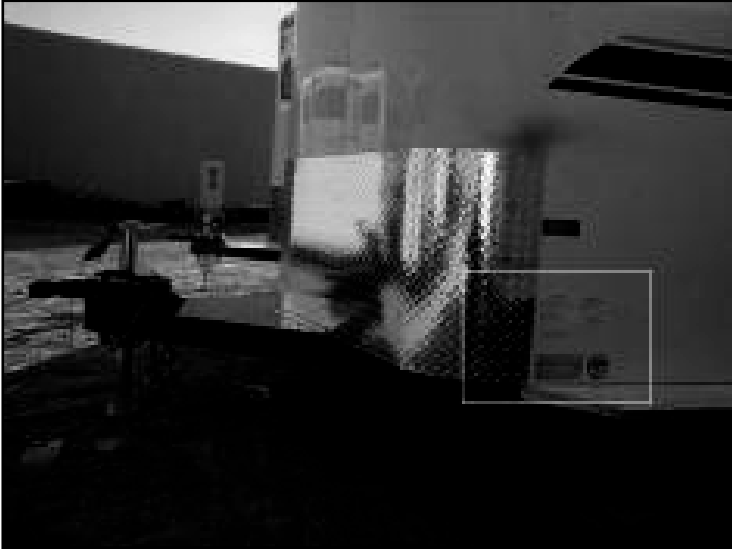

*Figure 1-2 Warning Labels and Locations*



## Safety Information

THIS TRAILER IS 102" WIDE. THIS WIDTH TRAILER IS LEGAL ON ALL U.S. FEDERALLY FUNDED HIGHWAYS. SOME STATE HIGHWAY REGULATIONS ARE LESS THAN 102". PLEASE CHECK YOUR LOCAL REGULATIONS.

### WARNING

You must check the following before towing, and at all stops:

1. Ball correct size and properly secured.
2. Coupler properly secured and safety lock pin installed.
3. Safety chains hooked up properly.
4. Front half of trailer must support and be loaded with 50% or more of the total load.
5. Brake check, so that brakes function properly.
6. All lights and turn signals working.
7. Lug nuts tight (90 lbs. torque) min.
8. Tire pressure meets manufacturers specifications.
9. All doors and gates are secured.
10. Safety pins and locks are secured and checked.

DO NOT EXCEED MAXIMUM  
RECOMMENDED WEIGHT  
FOR THIS TRAILER

### NOTICE!

#### CHECK WHEEL LUGS

1. On first trip, tighten wheel lugs at start and every 50 miles for first 200 miles. See Owners Manual for correct torque and torque sequence.
2. Thereafter, check wheel lugs before each trip.
3. Following winter storage, check before beginning a trip.
4. Following excessive braking, inspect wheel lugs.

TO PREVENT SEVERE FLOOR CORROSION TO THIS TRAILER: RUBBER MATS SHOULD BE REMOVED EVERY SIXTY DAYS AND TRAILER WASHED THOROUGHLY

### WARNING

PRIOR TO ACID-WASHING, RUBBER MATS MUST BE REMOVED. FOLLOWING ACID-WASHING, TRAILER MUST BE RINSED THOROUGHLY BEFORE RUBBER MATS ARE REPLACED. FAILURE TO DO SO WILL VOID WARRANTY.

## Safety Information

### SADDLE RACKS

BECAUSE OF THE MANY DIFFERENT SIZES AND SHAPES OF SADDLES AS WELL AS MOVEMENT OF TRAILERS IN TRANSPORT IT IS RECOMMENDED THAT ALL SADDLES BE TIED ONTO RACKS. SUNDOWNER DOES NOT GUARANTEE SADDLES TO STAY IN PLACE DURING TRANSPORT. EXTRA CARE SHOULD BE GIVEN FOR PROTECTION OF YOUR TACK.

### CAUTION

#### LATCH

**MUST BE PINNED OR LOCKED  
BEFORE TRANSPORTING**

Although all trailers are fully caulked and water-tested, there is no guarantee that this trailer will not leak.

THIS VEHICLE IS DESIGNED SPECIFICALLY FOR LIVESTOCK TRANSPORT ONLY, ANY OTHER USE IS NOT RECOMMENDED.

### CAUTION

Trailer weight, weight distribution, and tire inflation pressure are major factors in safe and economical towing of your travel trailer.

1. Use equalizer hitch with 2-5/16" hitch ball.
2. Tighten all lug nuts before first movement and every 50 miles for first 200 miles. Retighten before each trip thereafter. Correct torque is 90 to 95 foot pounds. See owner's manual for directions on changing a tire.
3. Tire pressure (cold tires) should be maintained at 35 PSI for 175/80 R13-B or 205/75 R140B or 205/75 R150B tires, and 50 PSI for 225/75 R15-C tires.
4. Braking performance of your towing vehicle and new trailer are affected by several factors including the respective size and weight of each vehicle. Make several low speed stops using the trailer brakes alone, followed by several low speed stops using both the brakes of the trailer and the towing vehicle before you make your first trip. Please refer to the installation instructions furnished with your electric brake controller for further information.
5. Avoid overloading. The total trailer weight (dry weight of standard unit + options added + water stored + liquid wastes in holding tanks + all cargo) must not exceed the gross vehicle weight rating (GVWR) stated on the tag on the front left side of your trailer.
6. The total load of your fully loaded trailer on the tires when connected to the towing vehicle must not exceed the combined total gross axle weight rating (GAWR). The GAWR is stated on the tag on the front left side of your trailer.
7. Establish the weight of your fully loaded trailer by weighting it at a public scale. Contact a police department for the location of the nearest one. Weigh separately:
  - A. The load on the front jack.
  - B. The total weight on the wheels and jack when disconnected from the towing vehicle.
  - C. The weight on the wheels when connected to the towing vehicle.
8. Do not permit the tongue weight ("7-A" above) to exceed your hitch manufacturer's recommendation. It should be 8-15% of the total trailer weight.
9. Weight "7-B" must not exceed the GVWR.
10. Weight "7-C" must not exceed the combined total GAWR.
11. Equalize side to side loading. Store heavy objects on or near the floor.
12. Avoid towing with waste holding tank(s) full. If unavoidable, drive slowly until one or both tanks can be dumped.
13. Keep water and waste holding tanks either completely full or empty when towing.

Contact your dealer for any questions on these rules and other towing tips.

CS-15-A



## Safety Information

READ & UNDERSTAND INSTRUCTIONS BEFORE OPERATING JACK.

**⚠ WARNING ⚠**

NEVER ATTEMPT TO MOVE PULL-PIN WHEN THERE IS ANY LOAD ON THE JACK. DOING SO COULD CAUSE THE TRAILER TO MOVE SUDDENLY.

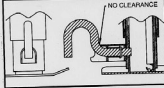
DROP LEG WILL AUTOMATICALLY RETRACT. KEEP CLEAR OF MOVING DROP LEG.

DROPLEG PULL-PIN ENGAGED (CLOSED)      DROPLEG PULL-PIN DISENGAGED (OPEN)

To extend drop leg:

1. Pull and rotate pull-pin handle 90° to the disengaged position to release drop leg.
2. Place foot on drop leg plate and extend drop leg to desired position.
3. While holding drop leg in desired position, rotate pull-pin handle 90° to the engaged position and release drop leg to allow the pull-pin to engage the desired hole.
4. Verify that pull-pin is fully engaged in hole by observing that pull-pin is fully seated and touching the uppermost position of housing.
5. Rotate jack handle to adjust jack to desired position.

To retract drop leg:

1. After properly supporting trailer load with trailer coupling device, rotate pull-pin handle 90° to the disengaged position. Dropleg will retract automatically. Keep clear of moving dropleg.
2. After drop leg retracts, rotate pull-pin handle 90° to the engaged position.
3. Verify that pull-pin is fully engaged in hole by observing that pull-pin is fully seated and touching the uppermost position of housing.
4. Rotate jack handle to adjust jack for desired ground clearance.

To obtain instruction sheet contact:  
Fulton Performance Products, Inc.  
(800)604-9466      0925225 (A)

WARNING

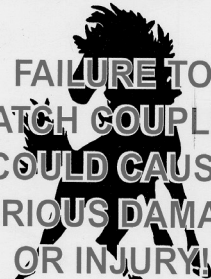

FAILURE TO LATCH COUPLER COULD CAUSE SERIOUS DAMAGE OR INJURY!

MAXIMUM ADJMT. 8"

1-405-224-5853 - CHICKASHA, OK 73023

GTW 25,000 Lbs.

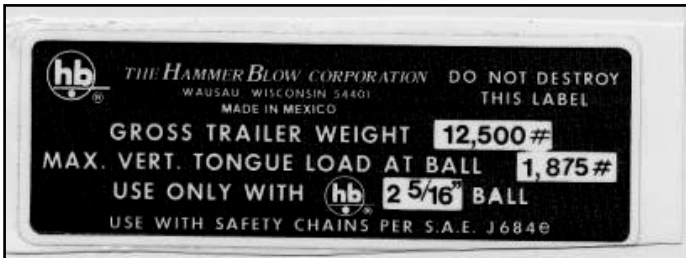

⚠ Warning

To protect you and others against death or serious injury, all the labels shown above must be on the trailer and must be legible.

If any of these labels are missing or cannot be read, call Sundowner Trailers, Inc. at (800) 654-3879.

You will need to provide us with the number shown at the bottom of the label(s) in order for us to send the correct one(s). Or a complete description of the label.

**⚠ DANGER**

Any motorized vehicle or any motorized equipment powered with flammable liquid can cause fire, explosion, or asphyxiation if stored or transported within the recreational vehicle. To reduce the risk of fire, explosion, or asphyxiation:

- (1) Passengers shall not ride in the vehicle storage area while vehicles are present.
- (2) Doors and windows in walls of separation (if installed) are to be closed while the vehicles are present.
- (3) Run fuel out of engine of stored vehicles after shutting off fuel at the tank.
- (4) Do not store or transport motor fuel inside this vehicle.
- (5) Ventilate the vehicle storage area.
- (6) Do not operate gas appliances, pilot lights, or electrical equipment when motorized vehicles or motorized equipment are inside vehicle.

**FAILURE TO COMPLY COULD RESULT IN AN INCREASED RISK OF FIRE, EXPLOSION, OR ASPHYXIATION.**

**⚠ Warning**

**DO NOT SLEEP IN THIS AREA.  
FAILURE TO COMPLY MAY RESULT IN  
DEATH OR SERIOUS INJURY.**

**NOTICE!  
CHECK WHEEL LUGS**

1. On first trip, tighten wheel lugs at start and every 50 miles for first 200 miles. See Owners Manual for correct torque and torque sequence.
2. Thereafter, check wheel lugs before each trip.
3. Following winter storage, check before Beginning a trip.
4. Following excessive braking, inspect wheel lugs.



**⚠ DANGER**

Any motorized equipment or heater powered with flammable liquid can cause fire, explosion, or asphyxiation if stored, transport, or operated within or nearby the trailer. To reduce the risk of fire, explosion, or asphyxiation:

- (1) Passengers shall not ride in towed trailer.
- (2) Occupants shall not sleep in the trailer while vehicles or motorized equipment are present.
- (3) Do not sleep in a trailer while operating a portable heater or generator, etc. as carbon monoxide poisoning can occur and may result in death or serious injury.
- (4) A trailer should only be used for transportation of its intended cargo.
- (5) Do not store or transport motor fuel inside this trailer.

FAILURE TO COMPLY COULD RESULT IN AN INCREASED RISK OF FIRE, EXPLOSION, ASPHYXIATION, DEATH OR SERIOUS INJURY.

**⚠ Warning**

**OVERLOAD HAZARD**

- RISK OF DEATH DUE TO LOSS OF CONTROL  
NEVER EXCEED GROSS VEHICLE WEIGHT RATING (GVWR)  
BEFORE LOADING THE TRAILER FOR THE FIRST TIME,  
YOU MUST VERIFY ITS CARGO CAPACITY:
1. **You**, MUST WEIGHT the EMPTY TRAILER.
  2. Subtract the weight of the EMPTY TRAILER from the MAXIMUM LOADED TRAILER WEIGHT (GVWR) (see VIN/SERIAL NO., tag).
  3. DO NOT LOAD TRAILER BEYOND VERIFIED CARGO CAPACITY.

MAXIMUM LOADED TRAILER  
(GVWR) = EQUALS

**MAXIMUM  
CARGO WEIGHT**

**+ PLUS  
WEIGHT OF EMPTY TRAILER**



UT0088

### **14.2.19. Trailer Towing Guide**

Driving a vehicle with a trailer in tow is vastly different from driving the same vehicle without a trailer in tow. Acceleration, maneuverability and braking are all diminished with a trailer in tow. It takes longer to get up to speed, you need more room to turn and pass, and more distance to stop when towing a trailer. You will need to spend time adjusting to the different feel and maneuverability of the tow vehicle with a loaded trailer. Because of the significant differences in all aspects of maneuverability when towing a trailer, the hazards and risks of injury are also much greater than when driving without a trailer. You are responsible for keeping your vehicle and trailer in control, and for all the damage that is caused if you lose control of your vehicle and trailer.

As you did when learning to drive an automobile, find an open area with little or no traffic for your first practice trailering. Of course, before you start towing the trailer, you must follow all of the instructions for inspection, testing, loading and coupling. Also, before you start towing, adjust the mirrors so you can see the trailer as well as the area to the rear of it.

Drive slowly at first, 5 m.p.h. or so, and turn the wheel to get the feel of how the tow vehicle and trailer combination responds. Next, make some right and left hand turns. Watch in your side mirrors to see how the trailer follows the tow vehicle because turning with a trailer attached requires more room.

Stop the rig a few times from speeds no greater than 10 m.p.h. If your trailer is equipped with brakes, try using different combinations of trailer/electric brake and tow vehicle brake. Note the effect that the trailer brakes have when they are the only brakes used. When properly adjusted, the trailer brakes will come on just before the tow vehicle brakes.

It will take practice to learn how to back up a tow vehicle with a trailer attached. Take it slow. Before backing up, get out of the tow vehicle and look behind the trailer to make sure that there are no obstacles. Some drivers place their hands at the bottom of the steering wheel, and while the tow vehicle is in reverse, “think” of the hands as being on the top of the wheel. When the hands move to the right (counter-clockwise, as you would do to turn the tow vehicle to the left when moving forward), the rear of the trailer moves to the right. Conversely, rotating the steering wheel clockwise with your hands at the bottom of the wheel will move the rear of the trailer to the left, while backing up. If you are towing a bumper hitch rig, be careful not to allow the trailer to turn too much because it will hit the rear of the tow vehicle. To straighten the rig, either pull forward or turn the steering wheel in the opposite direction.

### **Safe Trailer Towing Guidelines**

- ◆ Recheck the load tie-downs to make sure the load will not shift during towing.
- ◆ Before towing, check coupling, safety chain, safety brake, tires, wheels and lights.
- ◆ Check the lug nuts or bolts for tightness.
- ◆ Check coupler tightness after towing 50 miles.

## Safety Information

---

- ◆ Adjust the brake controller to engage the trailer brakes before the tow vehicle brakes. Your dealer can assist you by making this adjustment.
- ◆ Use your mirrors to verify that you have room to change lanes or pull into traffic.
- ◆ Use your turn signals well in advance.
- ◆ Allow plenty of stopping space for your trailer and tow vehicle.
- ◆ Do not drive so fast that the trailer begins to sway due to speed. Never drive faster than 60 m.p.h.
- ◆ Allow plenty of room for passing. A rule of thumb is that the passing distance with a trailer is four (4) times the passing distance without a trailer.
- ◆ Shift your automatic transmission into a lower gear for city driving.
- ◆ Use lower gears for climbing and descending grades.
- ◆ Do not ride the brakes while descending grades. They may get so hot that they stop working, which can potentially cause you to have a runaway tow vehicle and trailer.
- ◆ To conserve fuel, don't use full throttle to climb a hill. Instead, build speed on the approach.
- ◆ Slow down for bumps in the road and remove your foot off the brake when crossing the bump.
- ◆ Do not brake while in a curve unless absolutely necessary. Instead, slow down before you enter the curve and power through the curve. This way, the towing vehicle remains "in charge."
- ◆ Do not apply the brakes to correct extreme trailer swaying. Continued pulling of the trailer, and even slight acceleration, will provide a stabilizing force.
- ◆ Make regular stops about once each hour. Confirm that:
  - ⇒ the coupler is secure to the hitch and is locked,
  - ⇒ electrical connectors are made,
  - ⇒ there is appropriate slack in the safety chains,
  - ⇒ there is appropriate slack in the breakaway switch pullpin cable,
  - ⇒ the tires are not visibly low on pressure,
  - ⇒ your cargo is secure and in good condition and
  - ⇒ brake & clearance lights work.

# 15. COUPLING TO THE TOW VEHICLE

Follow all of the safety precautions and instructions in this manual to ensure safety of persons, cargo, and satisfactory life of the trailer.

## 15.1. USE AN ADEQUATE TOW VEHICLE AND HITCH

If the vehicle or hitch is not properly selected and matched to the Gross Vehicle Weight Rating (GVWR) of your trailer, you can cause an accident that could lead to death or serious injury. If you already have a tow vehicle, know your vehicle tow rating and make certain your trailer rating is equal to or less than that of the trailer. If you already have (or plan to buy) a trailer, make certain that the tow rating of the tow vehicle is equal to or greater than that of the trailer. The tow rating of your vehicle can be obtained from the vehicle dealership or your vehicle owners manual.

**⚠ Danger**

Be sure your hitch and tow vehicle are rated for the Gross Vehicle Weight Rating (GVWR) of your trailer.

### 15.1.1. Trailer Information

The “Trailer VIN Tag” location figure shows the location of the Vehicle Identification Number (VIN) tag on your trailer.

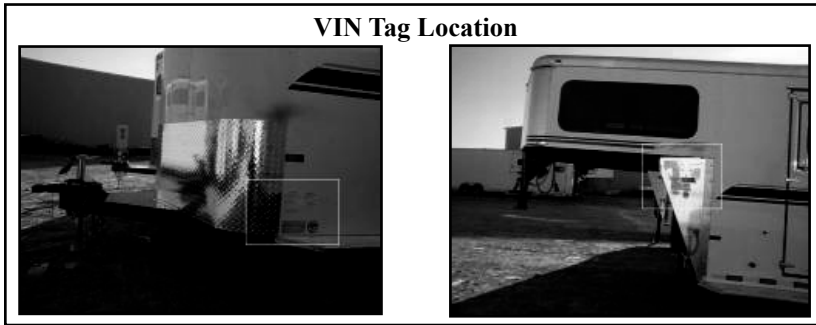

**VIN Tag Contents**

MANUFACTURED BY OR SERVICE FIRM: SUBCONTRACTOR TRAILERS, INC.		DATE: 06/18/02	
RECEIVED BY: (PRINT NAME)			
MANUFACTURED BY OR SERVICE FIRM: (PRINT NAME)		STANDARD NO.:	REV.:
GROSS WEIGHT: 4,800 kg / 10,520 lb		TRAILER TYPE:	AXLE TYPE:
GROSS WEIGHT: 2700 kg / 5950 lb		TRAILER TYPE: 172250001002	AXLE TYPE: 10000
GROSS WEIGHT: 2700 kg / 5950 lb		TRAILER TYPE: 172250001002	AXLE TYPE: 10000
GROSS WEIGHT: 2700 kg / 5950 lb		TRAILER TYPE: 172250001002	AXLE TYPE: 10000
VIN NO.: 125LD12011LA301		TYPE: 172250001002	
<small>THE VIN TAG CONTAINS ALL INFORMATION FEDERAL MOTOR VEHICLE SAFETY ACT REQUIREMENTS. THE USE OF THIS TAG IS REQUIRED FOR ALL TRAILERS MANUFACTURED AFTER 09/01/00. THE VIN TAG MUST BE PLACED IN THE FRONT OF THE TRAILER IN THE STATE OF MANUFACTURE. THE VIN TAG MUST BE PLACED IN THE FRONT OF THE TRAILER IN THE STATE OF MANUFACTURE. THE VIN TAG MUST BE PLACED IN THE FRONT OF THE TRAILER IN THE STATE OF MANUFACTURE. THE VIN TAG MUST BE PLACED IN THE FRONT OF THE TRAILER IN THE STATE OF MANUFACTURE.</small>			

## Coupling to the Tow Vehicle

---

The trailer VIN tag contains the following critical safety information for the use of your trailer.

**GAWR:** The maximum gross weight that an axle can support. It is the lowest of axle, wheel, or tire rating. Usually, the tire or wheel rating is lower than the axle rating and determines GAWR.

**GVWR:** The maximum allowable gross weight of the trailer and its contents. The gross weight of the trailer includes the weight of the trailer and all of the items within it (such as cargo, water, food and other supplies). GVWR is sometimes referred to as GTWR (Gross Trailer Weight Rating), or MGTW (Maximum Gross Trailer Weight). GVWR, GTWR and MGTW are all the same rating.

The sum total of the GAWR for all trailer axles may be less than the GVWR for the trailer because some of the trailer load is to be carried by the tow vehicle, rather than by the trailer axle(s). The total weight of the cargo and trailer must not exceed the GVWR, and the load on an axle must not exceed its GAWR.

**PSIC:** The tire pressure (Pounds per Square Inch) measured when cold.

**VIN:** The Vehicle Identification Number (17 digit).

**EMPTY WEIGHT:** Some information that comes with the trailer (such as the Manufacturer's Statement of Origin) is not a reliable source for "empty" or "net" weight. The shipping documents list average or standard weights and your trailer may be equipped with options. To determine the "empty" or "net" weight of your trailer, weigh it on an axle scale. Because an axle scale weighs all axles including the tow vehicle axles, and some of the trailer weight will be transferred from the trailer to the tow vehicle axles, you must know the axle weights of your tow vehicle without the trailer coupled to find the weight of the trailer using an axle scale.

### **15.1.2. Tow Vehicle**

When equipping a new vehicle or an older vehicle to tow your trailer, ask the vehicle dealer for advice on how to outfit the towing vehicle. Discuss the following information and equipment with the vehicle dealer.

#### 1. Overall Carrying and Towing Capacity of Vehicle

Vehicle manufacturers will provide you with the maximum capacities of their various models. No amount of reinforcement will give a 100 horsepower, 2,500 pound truck the towing capacity that a 300 horsepower, 5,000 pound truck has.

#### 2. Towing Hitch

The towing hitch attached to your tow vehicle must have a capacity equal to or greater than the load rating of the trailer you intend to tow. The hitch capacity must also be matched to

## Coupling to the Tow Vehicle

---

the tow vehicle capacity. Only your vehicle dealer can provide and install the proper hitch on your tow vehicle.

### 3. Suspension System

Sway bars, shock absorbers, heavy duty springs, heavy duty tires and other suspension components must be able to sufficiently serve the size and weight of the trailer that is going to be towed.

### 4. Brake Controller

The brake controller is part of the tow vehicle and is essential in the operation of the electric brakes on the trailer. Your manufacturer provides electric brakes on trailers with a GVWR of 3,000 pounds or more. The brake controller is not the same as the safety breakaway brake system that may be equipped on the trailer.

### 5. Side View Mirrors

The size of the trailer that is being towed and your state law regulations determine the size of the mirrors. However, some states prohibit extended mirrors on a tow vehicle, except while a trailer is actually being towed. In this situation, detachable extended mirrors are necessary. Check with your dealer or the appropriate state agency for mirror requirements.

### 6. Heavy Duty Flasher

A Heavy Duty Flasher is an electrical component that may be required when your trailer turn signal lights are attached to the tow vehicle flasher circuit.

### 7. Electrical Connector

An Electrical Connector connects the light and brake systems on the trailer to the light and brake controls on the towing vehicle.

### 8. Heavy Duty Engine Oil Cooling System

The tow vehicle engine works harder when a trailer is being towed. Depending on the size of the trailer, you may need to install a separate engine oil cooler. Inadequate cooling may result in sudden engine failure. Ask the tow vehicle dealer if it is necessary to install a heavy duty cooling system.

### 9. Automatic Transmission Oil Cooler

The automatic transmission of a tow vehicle handles more power when a trailer is being towed. Inadequate cooling will shorten transmission life, and may result in sudden transmission failure. Ask the tow vehicle dealer if it is necessary to install a separate oil cooler for the automatic transmission.

### 10. Fire Extinguisher

It is sensible to have a fire extinguisher in the tow vehicle.

### 11. Emergency Flares and Emergency Triangle Reflectors

It is wise to carry these warning devices even if you are not towing a trailer. It is particularly

## Coupling to the Tow Vehicle

---

important to have these when towing a trailer because the hazard flashers of your towing vehicle will not operate for as long a period of time when the battery is running both the trailer lights and tow vehicle lights.

### **15.2. COUPLING AND UNCOUPLING THE TRAILER**

A secure coupling (or fastening) of the trailer to the tow vehicle is essential. A loss of coupling may result in death or serious injury. Therefore, you must understand and follow all of the instructions for coupling.

The following parts are involved in making a secure coupling between the trailer and tow vehicle:

**Coupler:** A device on the tongue of the trailer that connects to the hitch on the tow vehicle.

**Hitch:** A device on the tow vehicle that supports the weight of the trailer tongue and pulls the trailer. The coupler attaches to the hitch.

**Safety chains:** If the coupler connection comes loose, the safety chains can keep the trailer attached to the tow vehicle. With properly rigged safety chains, it is possible to keep the tongue of the trailer from digging into the road pavement, even if the coupler-to-hitch connection comes apart.

**Trailer lighting (and braking) connector:** A device that connects electrical power from the tow vehicle to the trailer. Electricity is used to turn on brake lights, running lights, and turn signals as required. In addition, if your trailer has a separate braking system, the electrical connector will also supply power to the brakes from the tow vehicle.

**Breakaway switch:** If the coupler connection comes loose, the breakaway switch can activate emergency electrical brakes on the trailer. The breakaway switch must be rigged to the tow vehicle with appropriate slack that will activate the switch if the coupler connection comes loose.

**Jack:** A device on the trailer that is used to raise and lower the coupler. The jack is sometimes called the “landing gear.”

#### **Warning**

Do not move the trailer until:

- The coupler is secured and locked to hitch;
- The safety chains are secured to the tow vehicle; and
- The trailer jack(s) are fully retracted.

---

## Coupling to the Tow Vehicle

---

### **Various Coupler Designs . . .**

Trailers are produced with a variety of coupler devices. One of the sections below will pertain to your trailer.

- ◆ Ball Hitch Coupler
- ◆ Gooseneck Hitch Coupler
- ◆ Fifth Wheel Coupler

If the coupler on your trailer does not resemble one of the couplers shown in the figures, see the separate coupler instructions. If you do not have separate coupler instructions, call Sundowner Trailers, Inc. at (800) 654-3879 for a free copy.

#### **15.2.1. Trailer with Ball-Hitch Coupler**

A ball hitch coupler connects to a ball that is located on or under the rear bumper of tow vehicle. This system of coupling a trailer to a tow vehicle is sometimes referred to as “bumper pull.”

A ball hitch trailer may be fitted with a tongue jack that can raise and lower the coupler. The tongue jack is mounted to the A-frame (front or tongue) part of the trailer. By rotating the jack handle clockwise, the jack will extend and raise the tongue of the trailer.





## Coupling to the Tow Vehicle

---

We have utilized a Ball Hitch coupler that is suitable for the size and weight of the trailer. The load rating of the coupler and the necessary ball size are listed on the trailer tongue. You must provide a hitch and ball for your tow vehicle, where the load rating of the hitch and ball is equal to or greater than that of your trailer. Also, the ball size must be the same as the coupler size. If the hitch ball is too small, too large, is underrated, is loose or is worn, the trailer can come loose from the tow vehicle, and may cause death or serious injury.

THE TOW VEHICLE, HITCH AND BALL MUST HAVE A RATED TOWING CAPACITY EQUAL TO OR GREATER THAN THE TRAILER GVWR (Gross Vehicle Weight Rating).

IT IS ESSENTIAL THAT THE HITCH BALL BE OF THE SAME SIZE AS THE COUPLER.

The ball size and load rating (capacity) are marked on the ball; hitch capacity is marked on the hitch.

### 15.2.1.1. Before coupling the trailer to the tow vehicle

Be sure the size and rating of hitch ball match the size and rating of the coupler. Hitch balls and couplers are marked with their size and rating.

 <b>Warning</b>
Be sure the <b>LOAD RATING</b> of the hitch ball is equal or greater than the load rating of the coupler.
Be sure the <b>SIZE</b> of the hitch ball matches the size of the coupler.

- ◆ Wipe the hitch ball clean and inspect it visually and by feel for flat spots, cracks and pits.

 <b>Warning</b>
Before coupling trailer, inspect the hitch ball for wear, corrosion and cracks.
Replace worn or damaged hitch ball.

- ◆ Rock the ball to make sure it is tight to the hitch, and visually check that the hitch ball nut is solid against the lock washer and hitch frame.
- ◆ Wipe the inside and outside of the coupler clean and inspect it visually for cracks and deformations; feel the inside of the coupler for worn spots and pits.
- ◆ Be sure the coupler is tight to the tongue of the trailer. All coupler fasteners must be visibly solid against the trailer frame.

## Coupling to the Tow Vehicle

### Warning

Be sure the hitch ball is tight to the hitch before coupling the trailer.

- ◆ Raise the bottom surface of the coupler to be above the top of the hitch ball. Use the jack if one is provided; otherwise, use wood or concrete blocks to support the trailer tongue.

### 15.2.1.2. Prepare the coupler and hitch

- ◆ Lubricate the hitch ball and the inside of the coupler with a thin layer of automotive bearing grease. If your trailer is equipped with a jack, raise the coupler above the ball height.
- ◆ Open the coupler locking mechanism. Ball couplers have a locking mechanism with an internal moving piece and an outside handle.
  - ⇒ In the open position, the coupler is able to drop fully onto the hitch ball.
  - ⇒ See the coupler instructions for details of placing the coupler in the “open” position.
- ◆ Slowly back up the tow vehicle so that the hitch ball is near or aligned under the coupler, if the trailer jack has raised the coupler.

*Figure 2-1 Ball Hitch Coupler Mechanism  
Unlatched & Latched*



## Coupling to the Tow Vehicle

### 15.2.1.3. Couple the trailer to the tow vehicle

- ◆ With your jack, lower the trailer until the coupler fully engages the hitch ball. If the coupler does not line up with the hitch ball, adjust the position of the tow vehicle.
- ◆ Engage the coupler locking mechanism. In the engaged position, the locking mechanism securely holds the coupler to the hitch ball.
- ◆ Insert a pin or lock through the hole in the locking mechanism.
- ◆ Be sure the coupler is all the way on the hitch ball and the locking mechanism is engaged. A properly engaged locking mechanism will allow the coupler to raise the rear of the tow vehicle.

Using the trailer jack, test to see that you can raise the rear of the tow vehicle by 1 inch, after the coupler is locked to the hitch

#### **⚠ Notice**

Do not use the tongue jack to raise the tow vehicle more than 1 inch.

If the coupler cannot be secured to the hitch ball, do not tow the trailer. Call Sundowner Trailers, Inc. at (800) 654-3879 or your dealer for assistance.

- ◆ Lower the trailer so that its entire tongue weight is held by the hitch, and continue retracting the jack to its fully retracted position.

### 15.2.1.4. Rig the safety chains



Safety Chain Arrangement

Bumper Pull Trailer

## Coupling to the Tow Vehicle

- ◆ Visually inspect the safety chains and hooks for wear or damage. Replace worn or damaged safety chains and hooks before towing.
- ◆ Rig the safety chains so that they:
  - ⇒ cross underneath the coupler;
  - ⇒ loop around a frame member of the tow vehicle or to holes provided in the hitch system (but do not attach them to an interchangeable part of the hitch assembly); and
  - ⇒ have enough slack to permit tight turns, but not be close to the road surface, so if the trailer uncouples, the safety chains can hold the tongue up above the road.

### ⚠ Warning

- Fasten chains to frame of tow vehicle. Do not fasten chains to any part of the hitch unless the hitch has holes or loops specifically for that purpose.
- Cross chains underneath hitch and coupler with enough slack to permit turning and to hold tongue up, if the trailer comes loose.

### 15.2.1.5. Attach and test electric breakaway brake system

If the coupler or hitch fails, a properly connected and working breakaway brake system will apply electric brakes on the trailer. The safety chains will keep the tow vehicle attached and as the brakes are applied at the trailer's axles, the trailer/tow vehicle combination will come to a controlled stop.

The breakaway brake system includes a battery, a switch with a pullpin, and a breakaway brake controller. Read and follow the instructions here as well as the instructions that have been prepared by the breakaway brake controller manufacturer. If you do not have these instructions, call Sundowner Trailers, Inc. at (800) 654-3879 for a free copy.

The breakaway brake system may be fitted with a charging facility that draws power from the tow vehicle. If the electrical system on your tow vehicle does not provide power to the breakaway brake battery, you must periodically charge the battery to keep the breakaway brake system in working order.

Breakaway Brake

Bumper Pull  
Trailer



## Coupling to the Tow Vehicle

---

- ◆ Connect the pullpin cable to the tow vehicle so that the pullpin will be pulled out before all of the slack in the safety chains is taken up (see Breakaway Brake System figure on page 24). Do not connect the pullpin cable to a safety chain or to the hitch ball or hitch ball assembly. This would keep the breakaway brake system from operating when it is needed.
- ◆ Remove the pullpin from the switch and test tow the trailer, at less than 5 m.p.h. You should feel the trailer resisting being towed, but the wheels will not necessarily be locked. If the brakes do not function, do not tow the trailer until brakes are repaired.
- ◆ Immediately replace the pullpin. The breakaway brake system battery discharges rapidly when the pullpin is removed.

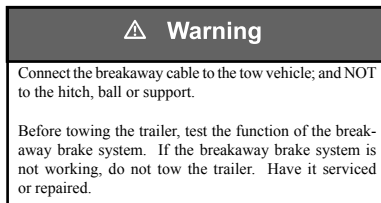

Do not tow the trailer with the breakaway brake system ON because the brakes will overheat which can result in permanent brake failure.

If you do not use your trailer for three or more months, or during winter months:

- Store the battery indoors; and
- Charge the battery every three months.

Replace the breakaway brake battery at intervals specified by manufacturer.

### 15.2.1.6. Connect the electrical cables

Connect the trailer lights to the tow vehicle's electrical system using the electrical connectors.

- ◆ Check all lights for proper operation:
  - ⇒ Clearance and Running Lights (Turn on tow vehicle headlights).
  - ⇒ Brake Lights (Step on tow vehicle brake pedal).
  - ⇒ Turn Signals (Operate tow vehicle directional signal lever).
  - ⇒ Apply tow vehicle Emergency Brake then,
  - ⇒ Backup Lights if so equipped (Put tow vehicle gear shift into reverse).
- ◆ Check electric brakes for proper operation

If your trailer has electric brakes, your tow vehicle will have an electric brake controller

---

---

## Coupling to the Tow Vehicle

---

that sends power to the trailer brakes. Before towing the trailer on the road, you must operate the brake controller while trying to pull the trailer in order to confirm that the electric brakes operate.

⚠ Warning
Before each tow:
<ul style="list-style-type: none"><li>• Check that the taillights, brake lights and turn signals work.</li><li>• Check that the electric brakes work by operating the brake controller inside the tow vehicle</li></ul>

### 15.2.1.7. Uncoupling the Ball Hitch Trailer with Tongue Jack

Follow these steps to uncouple your ball hitch trailer from the tow vehicle:

- ⇒ Block trailer tires to prevent the trailer from rolling, before jacking the trailer up.
- ⇒ Disconnect the electrical connector.
- ⇒ Disconnect the breakaway brake switch cable. Promptly replace the pullpin in the switchbox.
- ⇒ Disconnect the safety chains from the tow vehicle.
- ⇒ Unlock the coupler and open it.
- ⇒ Before extending the jack, make certain the ground surface below the jack pad will support the tongue load.
- ⇒ Rotate the jack handle (or crank) clockwise. This will slowly extend the jack and transfer the weight of the trailer tongue to the jack.

### 15.2.2. Trailer with Gooseneck Coupler and Drop-leg Jack

A gooseneck coupler on the trailer connects to a gooseneck ball that you must have installed in the bed and attached to the frame of the tow vehicle. This system of coupling a trailer to a tow vehicle permits the tow vehicle to turn to sharper angles than are permitted by a bumper hitch system. A gooseneck coupler consists of a tube in an inverted “U” shape and a gooseneck ball receiver. The “Trailer with Gooseneck Coupler” figure on page 27 shows a trailer with a gooseneck coupler.

## Coupling to the Tow Vehicle

---

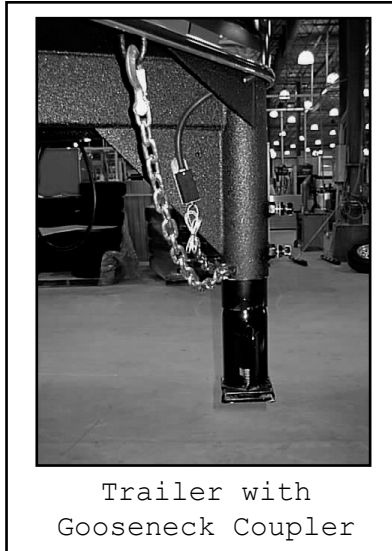

We have utilized a Gooseneck ball receiver that is suitable for the size and weight of the trailer. The load rating of the coupler and the necessary ball size are listed on the gooseneck.

You must provide a gooseneck ball and support structure that is marked with a rating that meets or exceeds the GVW of your trailer and matches the size of the gooseneck ball receiver. If the gooseneck ball is too small, is underrated, is loose or is worn, the trailer can come loose from the tow vehicle, and may lead to death or serious injury.

THE TOW VEHICLE, SUPPORT STRUCTURE AND GOOSENECK BALL MUST HAVE A RATED TOWING CAPACITY EQUAL TO OR GREATER THAN THE TRAILER Gross Vehicle Weight Rating (GVWR).

IT IS ESSENTIAL THAT THE GOOSENECK BALL BE OF THE SAME SIZE AS THE GOOSENECK BALL RECEIVER.

The gooseneck ball size and load rating (capacity) are marked on the ball; hitch capacity is marked on the hitch.

### Warning

Be sure the **LOAD RATING** of the hitch ball is equal or greater than the load rating of the coupler.

Be sure the **SIZE** of the hitch ball matches the size of the coupler.

## Coupling to the Tow Vehicle

---

The height of the ball receiver on the trailer must be adjusted to match the height of the gooseneck ball on your tow vehicle, so that:

- ⇒ there is clearance between the bottom of the trailer and the sides of the tow vehicle bed; and
- ⇒ the trailer is level and allows equal weight distribution on tandem axles.

The “Gooseneck Ball Receiver and Height Adjustment” figure below shows the gooseneck height adjustment. The gooseneck height adjustment bolts, which have a “cup” that makes a gripping impression into the gooseneck tube, must be tight so that the trailer does not drop to a lower position. Do Not over-tighten because the tube can be deformed. Minimum torque is 100 p.s.i. and maximum is 150 p.s.i. After tightening the bolts, tighten the jam nuts on the bolts. If there is a spacer sleeve on the coupler do not remove. This prevents the coupler from accidentally being shoved up into the nose pan.

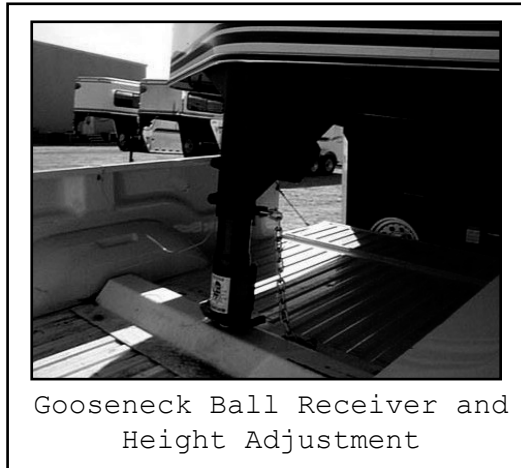

### Warning

Improper gooseneck height adjustment can result in overloaded tires, blowout and loss of control.

Adjust the gooseneck receiver so that the loaded trailer is level.

A trailer having a gooseneck hitch will have one or two drop leg jacks for raising and lowering the gooseneck ball receiver. Because we use several drop leg jack mechanisms, the general instructions below may vary slightly from the jack manufacturer’s instructions. If you do not have these instructions, call Sundowner Trailers, Inc. at (800) 654-3879 for a free copy.



## Coupling to the Tow Vehicle

---

Before attempting to tow the trailer:

- ◆ Be sure the size and rating of the gooseneck ball match the size and rating of the receiver. Gooseneck balls and receivers are marked with their size and ratings.
- ◆ Wipe the gooseneck ball clean and inspect it visually and by feel for flat spots, cracks and pits.

**⚠ Warning**

Before coupling the trailer, inspect the gooseneck ball for wear, corrosion and cracks; and replace worn or damaged gooseneck ball.

- ◆ Rock the ball to make sure it is tight to the ball support, and visually check that the gooseneck ball nut is solid against the lock washer and ball support frame.

**⚠ Warning**

Be sure the gooseneck ball nut is tight before coupling the trailer.

- ◆ Wipe the inside and outside of the receiver clean and inspect it visually for cracks; and feel the inside of the receiver for worn spots and pits. If any of these conditions exist, have the receiver replaced before coupling the trailer.
- ◆ Lubricate the inside of the gooseneck ball receiver with automotive bearing grease.
- ◆ Be sure the receiver is tight to the trailer. All receiver fasteners must be visibly solid against the trailer frame.
- ◆ Release the jack handle or crank from its holder.
- ◆ Make certain the ground beneath the jack foot is firm enough to support the tongue weight.
- ◆ Rotate the handle/crank clockwise to raise the bottom surface of the gooseneck to be above the top of the gooseneck ball.

### 15.2.2.1. Prepare the ball receiver and gooseneck ball

- ◆ Release the lock plate on the gooseneck ball receiver. With the spring-loaded lock plate locking pin in the OPEN position, rotate the lock plate to a position that allows the gooseneck ball to enter the receiver.
- ◆ If the tow vehicle is equipped with a tail gate, lower it.
- ◆ Slowly back up the tow vehicle so that the gooseneck ball is aligned under the gooseneck ball receiver.

**⚠ Warning**

There must be no one under the trailer or coupler, in case the trailer drops before or during coupling.

## Coupling to the Tow Vehicle

### 15.2.2.2. Couple the trailer to the tow vehicle

- ◆ Rotate the jack handle counter-clockwise. This will retract the jack causing the gooseneck ball receiver to drop down so it can fully engage the gooseneck ball and transfer the weight of the trailer tongue to the towing vehicle hitch. If the receiver does not line up with the ball, raise the receiver again and adjust the position of the tow vehicle. Then lower the receiver over the ball. When the drop leg base is no longer resting on the ground, the tow vehicle hitch is holding all of the weight of the trailer tongue.
- ◆ Close the lock plate on the gooseneck ball receiver.
- ◆ Move the spring-loaded lock plate locking pin to the CLOSED position. Be sure the locking pin is holding the lock plate.
- ◆ Be sure the receiver is all the way on the gooseneck ball and the lock plate is engaged. A properly engaged locking mechanism will allow the coupler to raise the rear of the tow vehicle. Using the trailer jack, test to see that you can raise the rear of the tow vehicle by 1 inch.

#### Notice

Do not use the drop leg jack to raise the tow vehicle more than 1 inch.

If the gooseneck ball cannot be secured to the receiver, do not tow the trailer. Call Sundowner Trailers, Inc. at (800) 654-3879 or your dealer for assistance.

- ◆ After testing to see that the receiver is properly secured and locked to the ball, retract the jack to its fully retracted position.
- ◆ Return the drop legs to their upper positions. The drop legs are held in the lowered position with a plunger pin. Rotating the plunger pin while pulling it outward will cause it to come out of engagement with the drop leg and the leg will rapidly rise.

#### Drop Leg Mechanism



## Coupling to the Tow Vehicle

---

### **Caution**

The drop legs are heavily spring loaded in the lowered position. They will rapidly return to the upper position when released.

Keep your feet, shins and hands well clear of the drop legs and drop leg bases when releasing the drop legs.

Always wear shoes or boots while performing this operation

### 15.2.2.3. Rig the safety chains

- ◆ Visually inspect the safety chains and hooks for wear or damage. Replace worn or damaged safety chains and hooks before towing.

⇒ Rig the safety chains so that they attach to the “safety chain receivers” on the hitch. If you are not certain of the hitch provisions for receiving safety chains, contact the hitch manufacturer or installer. (Do NOT attach the safety chains to the gooseneck ball or its support); and

⇒ Rig the safety chains so they have sufficient slack to permit turning, but not too much slack the safety chains must keep the gooseneck on the tow vehicle bed if the trailer uncouples.

### **Warning**

- Fasten chains to safety chain receivers on the hitch, not to ball.
- Have sufficient slack to permit turning and to keep gooseneck on bed of trailer, if the trailer comes loose.

### 15.2.2.4. Attach and test the breakaway brake system

If the coupler or hitch fails, a properly connected and working breakaway brake system will apply electric brakes on the trailer. The safety chains will keep the tow vehicle attached and as the brakes are applied at the trailer’s axles, the trailer/tow vehicle combination will come to a controlled stop.

The breakaway brake system includes a battery, a switch with a pullpin, and a breakaway brake controller. Read and follow the instructions here as well as the instructions that have been prepared by the breakaway brake controller manufacturer. If you do not have these instructions, call Sundowner Trailers, Inc. at (800) 654-3879 for a free copy.

## Coupling to the Tow Vehicle

---

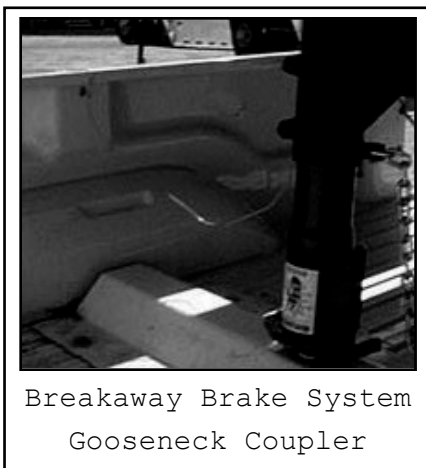

Breakaway Brake System  
Gooseneck Coupler

The breakaway brake system may be fitted with a charging facility that draws power from the tow vehicle. If the electrical system on your tow vehicle does not provide power to the breakaway brake battery you must periodically charge the battery on the trailer to keep the breakaway brake system in working order.

- ◆ Visually inspect the breakaway brake system for broken parts.
- ◆ Connect the pullpin cable to the tow vehicle so that the pullpin will be pulled out before all of the slack in the safety chains is taken up. Do Not connect the pullpin cable to a safety chain, a safety chain receiver, to the gooseneck ball or its support. Doing so would keep the breakaway brake system from operating when it is needed. Contact the hitch manufacturer or installer if you are not certain of the hitch provisions for breakaway brake connection.
- ◆ Remove the pullpin from the switch and test tow the trailer at less than 5 m.p.h. You should feel the trailer resisting being towed, but the wheels will not necessarily be locked.
- ◆ Immediately replace the pullpin. The breakaway brake system battery discharges rapidly when the pullpin is removed.

### **Warning**

Connect the breakaway cable to the tow vehicle; and NOT to the safety chain, safety chain receiver, gooseneck ball.

Do not tow the trailer if the breakaway brake system is not working.

### **Warning**

When testing brake-away system **make sure** trailer plug is disconnected from tow vehicle.

Engaging brake-away system with trailer plug connected can cause short in brake controller, **destroying it!**

## Coupling to the Tow Vehicle

---

Do Not tow the trailer with the breakaway brake system ON because the brakes will overheat which can result in permanent brake failure.

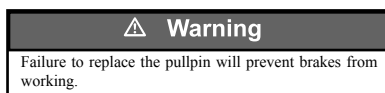

If you do not use your trailer for three or more months, or during winter months:

- ⇒ Store the battery indoors; and
- ⇒ Charge the battery every three months.

Replace the breakaway brake battery at intervals recommended by the battery manufacturer's instructions.

### 15.2.2.5. Connect the electrical cables

Connect the trailer lights to the tow vehicle's electrical system using the electrical connectors.

◆ Check all lights for proper operation:

- ⇒ Clearance and Running Lights (Turn on tow vehicle headlights).
- ⇒ Brake Lights (Step on tow vehicle brake pedal).
- ⇒ Turn Signals (Operate tow vehicle directional signal lever).
- ⇒ Apply tow vehicle Emergency Brake, then
- ⇒ Backup Lights if so equipped (Put tow vehicle gear shift into reverse).

◆ Check electric brakes for proper operation

If your trailer has electric brakes, your tow vehicle will have an electric brake controller that sends power to the trailer brakes. Before towing the trailer on the road, you must operate the brake controller while trying to pull the trailer in order to confirm that the electric brakes operate. While towing the trailer at less than 5 m.p.h., manually operate the electric brake controller in the tow vehicle cab. You should feel the operation of the trailer brakes.

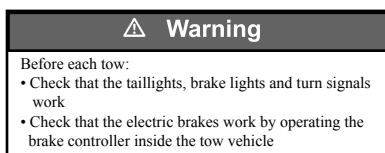

### 15.2.2.6. Uncoupling the Gooseneck Trailer with Drop-leg Jack

Follow these steps to uncouple your gooseneck hitch trailer from the tow vehicle:

◆ Block trailer tires to prevent the trailer from rolling before jacking the trailer up.

---

## Coupling to the Tow Vehicle

---

- ◆ Disconnect the electrical connector.
- ◆ Disconnect the breakaway brake switch cable. Promptly replace the pin in the switchbox.
- ◆ Disconnect the safety chains from the tow vehicle.
- ◆ Move the spring-loaded gooseneck receiver lock plate locking pin to the OPEN position.
- ◆ Rotate the lock plate to a position that permits the gooseneck ball to exit the receiver.
- ◆ Before releasing the dropleg jack, make certain the ground surface below the jack base will support the trailer tongue load.
- ◆ Rotate the drop leg plunger pin handle so that the plunger pin is released from the drop leg.
- ◆ Push down on the drop leg base with your foot to place a drop leg to the desired lowered position.
- ◆ Rotate the plunger pin handle so that the plunger pin is attempting to engage the drop leg.
- ◆ Slowly raise your foot, permitting the drop leg to raise. The plunger pin will engage a hole in the drop leg.

### **Caution**

The drop legs are heavily spring loaded in the lowered position. Keep your feet, shins and hands well clear of the drop legs and drop leg bases when releasing the drop legs.

Always wear shoes or boots while performing this operation.

- ◆ Be sure the plunger pin is fully engaged. Push it in by hand if necessary. The bent part of the plunger pin handle must be touching the plunger pin housing.
- ◆ If your trailer has two drop leg jacks, lower them both to the same level, following the above instructions.

### **Notice**

If the drop legs are not set at the same level, one of the drop leg jacks can be overloaded.

Release the handle (or crank) from its holder and engage it with the jack shaft.

- ◆ Rotate the handle (or crank) from its hold and engage it with the jack shaft.
- ◆ Rotate the handle (or crank) clockwise to slowly extend the jack and transfer the weight of the trailer tongue to the jack.
- ◆ On two speed jacks, pushing the handle shaft toward the gearbox can perform rapid extension. This shifts the gearbox into a high speed mode.
- ◆ When the drop leg base contacts the ground, shift the gearbox into low speed mode by pulling out on the handle shaft until it locks into low gear.

### **Notice**

Do not use high speed to lift the trailer.

## Coupling to the Tow Vehicle

---

Continue to extend the jack(s), making sure that the ground is providing stable and level support for the trailer.

After the jack(s) are extended and the gooseneck ball receiver is well clear of the gooseneck ball to permit driving the tow vehicle away, disengage the handle from its shaft and return to its holder.

### **15.2.3. Trailer with Fifth-wheel Coupler and Drop-leg Jack**

A fifth wheel coupler on the trailer (see “Fifth Wheel Coupler” figure below) connects to a kingpin that you must have installed in the bed of the tow vehicle. This system of coupling a trailer to a tow vehicle has a greater tongue weight capacity than a ball hitch or gooseneck coupling.

A fifth wheel coupler includes a flat load-bearing plate with a slot, and a mechanism inside the slot that “grips” the kingpin.

We have utilized a fifth wheel coupler that is suitable for the size and weight of the trailer. You must provide a kingpin and kingpin plate that match the fifth wheel, and that is rated for the Gross Vehicle Weight Rating (GVWR) of your trailer.

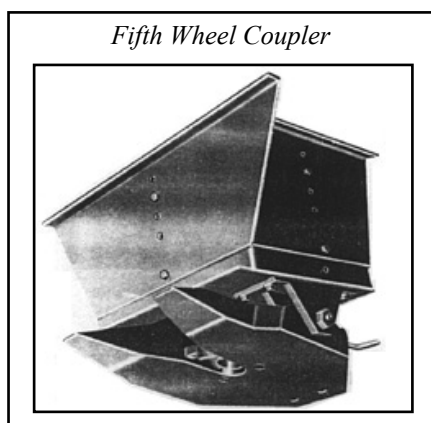

#### **15.2.3.1. Before attempting to tow the trailer**

- ◆ Be sure the size and rating of the fifth wheel and kingpin match.
- ◆ Wipe the kingpin clean and inspect it visually and by feel for flat spots, cracks and pits.
- ◆ Check the condition of the kingpin mounting in the bed of the tow vehicle.

## Coupling to the Tow Vehicle

---

### Warning

Before coupling the trailer, inspect the kingpin and kingpin plate for wear, bending, cracks or corrosion; and replace worn or damaged kingpin.

- ◆ Be sure the fifth wheel mechanism operates freely.
- ◆ Lubricate the fifth wheel plate surface with a light coat of Lithium-base, waterproof grease.
- ◆ Be sure the fifth wheel and kingpin fasteners are tight and any welds are solid.

### Warning

Be sure the fifth wheel and kingpin are tight before coupling the trailer.

- ◆ Be sure the brake line, electrical line, and any other lines are clear of the coupling area.
- ◆ Be sure the locks are open (see “Fifth Wheel Coupler Operation” figure on page 37).
- ◆ If the tow vehicle is equipped with a tailgate, lower it.
- ◆ Block the trailer wheels, front and rear.
- ◆ Make certain that trailer fifth wheel plate is slightly above the kingpin plate on the tow vehicle.
- ◆ Back tow vehicle up close to the trailer, centering the kingpin in the slot of the fifth wheel.
- ◆ *STOP* before engaging the coupling.

### Warning

There must be no one under the trailer or coupler before or during the coupling operation.

- ◆ Adjust the height of the trailer, using the jack, so that the fifth wheel plate just touches the kingpin plate.
- ◆ Slowly back up the tow vehicle, keeping the kingpin centered in the slot of the fifth wheel. Continue backing up until the fifth wheel locks firmly on the kingpin.
- ◆ Visually check to confirm that the fifth wheel locks are properly locked onto the kingpin by performing the three checks illustrated in the “Fifth Wheel Coupler Operation” figure on page 37.
- ◆ Attempt to pull forward as an initial test of the closing of the fifth wheel locks.



## Coupling to the Tow Vehicle

Figure 2-2 Fifth Wheel Coupler Operation

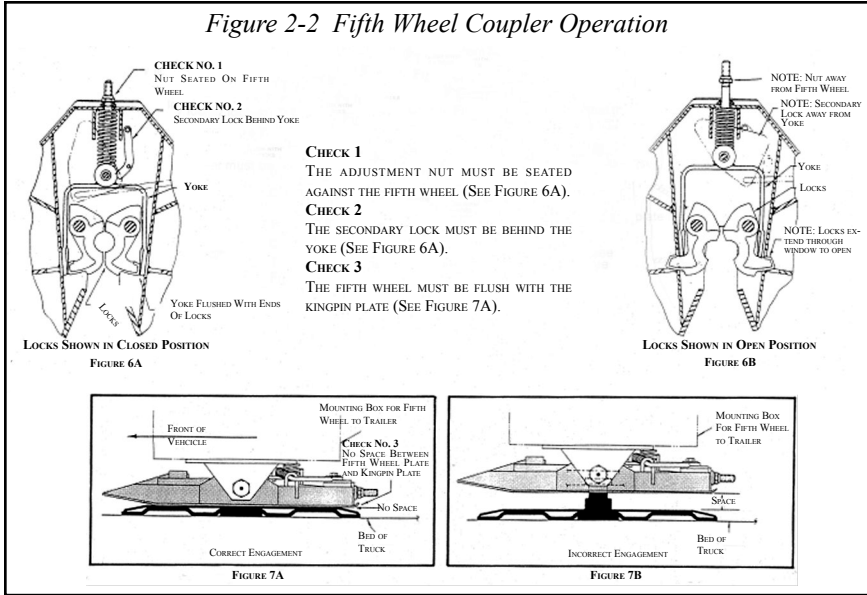

### ⚠ Warning

An improperly coupled fifth wheel can come loose.

Do not tow the trailer until all of the visual checks have been performed:

- Adjustment nut against fifth wheel.
- Secondary lock behind yoke.
- Fifth wheel against kingpin plate.

## Raise the Drop Leg Jack

A trailer having a fifth wheel coupler will be outfitted with one or two drop leg jacks for raising and lowering the fifth wheel coupler. Because we use several drop leg jack mechanisms, the general instructions below may vary slightly from the jack manufacturer's instructions. If the trailer jack on your trailer does not resemble the jack shown in the figures, follow the jack instructions provided by the jack manufacturer. If you do not have these instructions, call Sundowner Trailers, Inc. at (800) 654-3879 for a free copy.

- ◆ Rotate the jack handle counter-clockwise. This will slowly retract the jack and transfer the weight of the trailer tongue to the towing vehicle. When the drop leg base is no longer resting on the ground, the towing vehicle hitch is holding all of the weight of the trailer tongue. Continue retracting the jack to its fully retracted position.
- ◆ Return the drop legs to their upper positions. The drop legs are held in the lowered position with a plunger pin. Rotating the plunger pin while pulling it outward about

## Coupling to the Tow Vehicle

---

$\frac{3}{4}$  of an inch will cause it to come out of the engagement with the drop leg. The leg will rapidly raise.

- ◆ Raise the tailgate.
- ◆ Pick up the trailer wheel blocks.

### 15.2.3.2. Attach and test the breakaway brake system

If the coupler fails, a properly connected and working breakaway brake system will apply electric brakes on the trailer.

The breakaway brake system includes a battery, a switch with a pullpin, and a breakaway brake controller. Read and follow the instructions here as well as the instructions that have been prepared by the breakaway brake controller manufacturer. If you do not have these instructions, call Sundowner Trailers, Inc. at (800) 654-3879 for a free copy.

The breakaway brake system may be fitted with a charging facility that draws power from the tow vehicle. If the electrical system on your tow vehicle does not provide power to the breakaway brake battery, you must periodically charge the battery to keep the breakaway brake system in working order.

- ◆ Visually inspect the breakaway brake system for broken parts.
- ◆ Connect the pullpin cable to the tow vehicle. Do Not connect to kingpin or its support.
- ◆ Remove the pullpin from the switch and test tow the trailer at less than 5 m.p.h. You should feel the trailer resisting being towed, but the wheels will not necessarily be locked.
- ◆ Immediately replace the pullpin. The breakaway brake system battery discharges rapidly when the pullpin is removed.

#### **Warning**

Connect the breakaway cable to the tow vehicle, and NOT to the kingpin or its support.

Before towing the trailer, test the function of the breakaway brake system. If the breakaway brake system is not working, do not tow the trailer. Have it serviced or repaired.

Do Not tow the trailer with the breakaway brake system ON because the brake will overheat which can result in permanent brake failure.

#### **Warning**

Failure to replace the pullpin will prevent brakes from working, leading to loss of control.

## Coupling to the Tow Vehicle

---

If you do not use your trailer for three or more months, or during winter months:

- ⇒ Store the battery indoors; and
- ⇒ Charge the battery every three months.

Replace the breakaway brake battery at intervals recommended by the battery manufacturer.

### 15.2.3.3. Connect the electrical cables

- ◆ Connect the trailer lights to the tow vehicle's electrical system using the electrical connectors. Check all lights for proper operation:
  - ⇒ Clearance and Running Lights (Turn on tow vehicle headlights).
  - ⇒ Brake Lights (Step on Tow vehicle brake pedal).
  - ⇒ Turn Signals (Operate tow vehicle directional signal lever).
  - ⇒ Apply vehicle Emergency Brake, then
  - ⇒ Backup Light (Put tow vehicle gear shift into reverse).
- ◆ Check brakes for proper operation: While towing the trailer at less than 5 m.p.h., manually operate the electric brake controller in the tow vehicle cab. You should feel the operation of the trailer brakes.

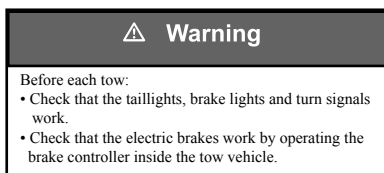

### 15.2.3.4. Uncoupling the Fifth-Wheel Trailer with Drop-leg Jack

Follow these steps to uncouple your fifth wheel hitch trailer from your tow vehicle:

- ◆ Block trailer tires to prevent the trailer from rolling before jacking the trailer up.
- ◆ Disconnect the electrical connector.
- ◆ Disconnect the breakaway brake switch cable. Promptly replace the pin in the switch.
- ◆ If the tow vehicle has a tailgate, lower it.
- ◆ Make certain that the ground surface below the jack base will support the trailer tongue load.
- ◆ Rotate the drop leg plunger pin handle so that the plunger pin is released from the drop leg.
- ◆ Push down on the drop leg base with your foot to place a drop leg to the desired lowered position.

## Coupling to the Tow Vehicle

---

### **Caution**

The drop legs are heavily spring loaded in the lowered position. Keep your feet, shins and hands well clear of the drop legs and drop leg bases when releasing the drop legs.

Always wear shoes or boots while performing this operation

- ◆ Rotate the plunger pin handle so that the plunger pin is attempting to engage the drop leg.
- ◆ Slowly raise your foot, permitting the drop leg to raise. The plunger pin will engage a hole in the drop leg.
- ◆ Be sure the plunger pin is fully engaged. Push it in by hand if necessary. The bent part of the plunger pin handle must be touching the plunger pin housing.
- ◆ If your trailer has two drop leg jacks, lower them both to the same level, following the above instructions.
- ◆ Release the handle (or crank) from its holder and engage it with the jack shaft.
- ◆ Rotate the handle (or crank) clockwise to slowly extend the jack and transfer the weight of the trailer tongue to the jack.
- ◆ On two speed jacks, pushing the handle shaft toward the gearbox can perform rapid extension. This shifts the gearbox into a high speed mode.
- ◆ When the drop leg base contacts the ground, shift the gearbox into low speed mode by pulling out on the handle shaft until it locks into low gear.

### **Notice**

High speed is used only to rapidly move the drop leg base into contact with the ground.

- ◆ Continue to extend the jack(s), making sure that the ground is providing stable and level support for the trailer.
- ◆ Turn the crank two or three turns to take some of the weight of the coupling. Do Not raise the fifth wheel off the kingpin plate.
- ◆ After the jack(s) are extended enough to permit driving the tow vehicle away, disengage the jack handle from its shaft and return it to its holder. Do NOT drive the tow vehicle yet!

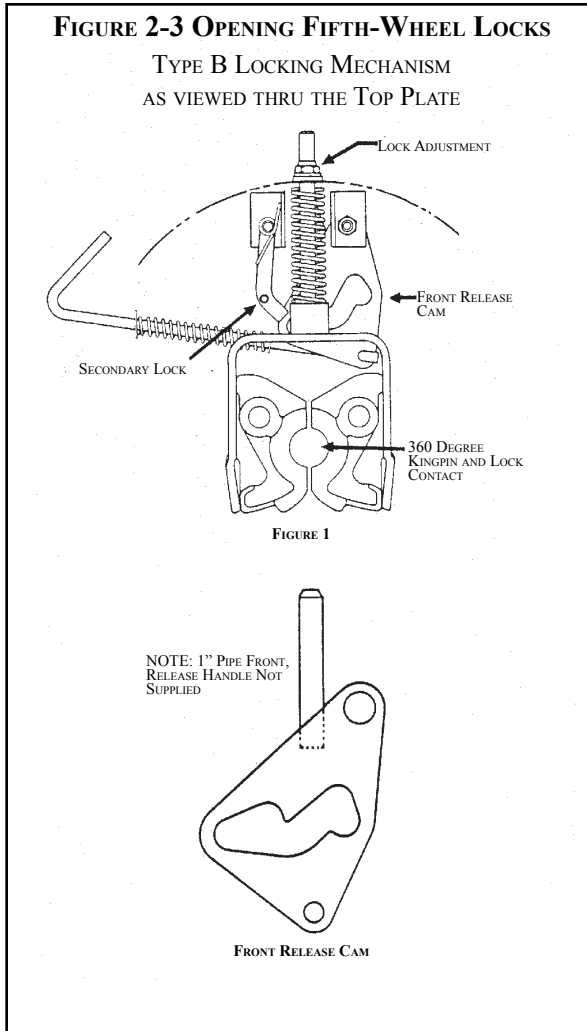

- ◆ Open the fifth wheel locks by:
  - ⇒ pulling the release handle, or
  - ⇒ using a separate pipe release handle to engage the solid stud on the secondary lock (see “Fifth Wheel Coupler Operation” page 37 and “Opening Fifth Wheel Locks” (above) figures).
- ◆ Slowly drive the tow vehicle away from the trailer.
- ◆ Raise the tow vehicle tailgate.

# 16. LOADING THE TRAILER

---

Improper trailer loading causes many accidents and deaths. To safely load a trailer, you must consider:

- ⇒ Overall load weight;
- ⇒ Load weight distribution;
- ⇒ Proper tongue weight; and
- ⇒ Securing the load properly.

To determine that you have loaded the trailer within its rating, you must consider the distribution of weight, as well as the total weight of the trailer and its contents. The trailer axles carry most of the total weight of the trailer and its contents (Gross Vehicle Weight, or “GVW”). The remainder of the total weight is carried by the tow vehicle hitch. It is essential for safe towing that the trailer tongue and tow vehicle hitch carry the proper amount of the loaded trailer weight, otherwise the trailer can suddenly sway wildly at towing speed. Read the “Tongue Weight” section below.

Towing stability also depends on keeping the center of gravity as low as possible. Load heavy items on the floor and over the axles. When loading additional items, be sure to maintain even side-to-side weight distribution and proper tongue weight. The total weight of the trailer and its contents must never exceed the total weight rating of the trailer (Gross Vehicle Weight Rating, or “GVWR”).

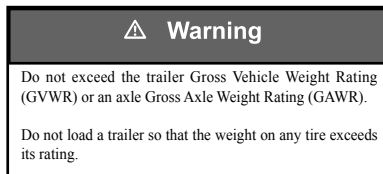

## Tongue Weight

It is critical to have a portion of the trailer load carried by the tow vehicle. That is, the trailer tongue must exert a downward force on the hitch. This is necessary for two reasons. First, the proper amount of tongue weight is necessary for the tow vehicle to be able to maintain control of the tow vehicle/trailer system. If, for example, the tongue exerts an upward pull on the hitch, instead of pushing down on it (because the trailer is overloaded behind its axle(s)), the rear wheel of the tow vehicle can lose traction or grip and cause loss of control. Also, even if there is some weight but not enough on the tongue, the trailer can suddenly become unstable at high speeds.

If, on the other hand, there is too much tongue weight, the front wheels of the tow vehicle can become too lightly loaded and cause loss of steering control and traction, especially when driving.

In addition to tow vehicle control, tongue weight is necessary to insure that the trailer axle(s) do not exceed their Gross Axle Weight Rating (GAWR).

## Loading the Trailer

The table below has “rules of thumb” for proper tongue weight.

In the table below, the second column notes the rule of thumb percentage of total weight of the trailer plus its cargo (Gross Vehicle Weight, or “GVW”) that should appear on the tongue of the trailer. For example, a trailer with a gooseneck hitch with a loaded weight of 12,000 pounds should have 20-25% of 12,000 pounds on the tongue. That is, the example trailer would have 2,400 to 3,000 pounds on its tongue. For some trailers (usually longer trailers) that, by design, require greater cargo loads in front of the axles, the tongue weight percentage could be greater than 25%. To determine the tongue weight for these trailers, it will be necessary to weigh the tow vehicle only with the loaded trailer coupled (for this method, make sure the trailer is straight and level with the tow vehicle so the weight will be accurate), then subtract the tow vehicle weight uncoupled, from the tow vehicle weight coupled. The remainder will give you actual tongue weight.

Tongue Weight as a Percentage of Loaded Trailer Weight for Standard Trailers	
Type of Hitch	Percentage
Ball Hitch (or Bumper Hitch)	10-15%
Gooseneck Hitch	20-25%
Fifth Wheel Hitch	

### Warning

Make certain that tongue weight is within the allowable range.

Be sure to:

- Distribute the load front-to-rear to provide proper tongue weight (see chart);
- Distribute the load evenly, right and left, to avoid tire overload; and
- Keep the center of gravity low.

### **16.1. CHECKING TONGUE WEIGHT**

To check the tongue weight, the tow vehicle and trailer must be on level ground, as they will be when the trailer is being towed.

If you know the weight on your tow vehicle axles when you are not towing a trailer, the trailer tongue weight can be determined with the use of a truck axle scale.

The recommended method of checking tongue weight is to use an accessory called a “tongue weight scale.” If a tongue weight scale is not available from your dealer, call Sundowner Trailers, Inc. at (800) 654-3879 for assistance.

## Loading the Trailer

---

### Checking Tongue Weight

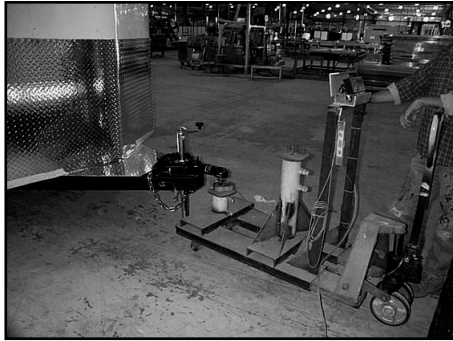

An alternate method of checking tongue weight involves the use of a bathroom scale. The loaded trailer must be on a smooth and level surface, and you must block the trailer wheels, front and rear.

#### **⚠ Warning**

An unrestrained trailer can fall off its support.

Before checking tongue weight, block trailer wheels, front and rear.

- ◆ Raise the tongue of the trailer with the jack.
  - ◆ Place a bathroom scale on the ground, directly below the coupler.
  - ◆ Place a strong block support (such as a cement block) on the scale note the scale reading for the weight of the block support.
  - ◆ Lower the tongue until the coupler rests on the block support and the jack is half an inch above the ground.
  - ◆ The scale reading, minus the weight of the block support is the tongue weight.
  - ◆ If the tongue weight exceeds the capacity of a bathroom scale, you can use “leverage” to divide the tongue weight between the bathroom scale and another support.
- 
- ⇒ Raise the tongue of the trailer with the jack.
  - ⇒ Arrange a brick, 2 x 4 (or 4 x 4) board, bathroom scale and pipes. The brick should be about the same thickness as the bathroom scale.
  - ⇒ Leave a three (3) foot distance between the pipes, and place the coupler about two (2) feet from the pipe on the bathroom scale.
  - ⇒ Place a strong block support (such as a cement block) on the board. Note the weight indicated on the scale.
  - ⇒ Lower the tongue until the coupler rests on the block support and the jack is half an inch above the ground.



## Loading the Trailer

---

⇒ Subtract the scale reading with the block and board alone from the scale reading with the trailer on the block. Multiply the result by three (3) to get the actual tongue weight.

⇒ Example:

⇒ Scale reading with block and board alone = 10 lbs.

⇒ Scale reading with trailer coupler resting on board = 50 lbs.

⇒ Actual tongue weight:  $(50-10) \times 3 = 120$  lbs.

◆ The tongue weight can also be checked at an axle weighing scale.

### **16.2. SECURING THE CARGO**

Since the trailer “ride” can be bumpy and rough, you must secure your cargo so that it does not shift while the trailer is being towed.

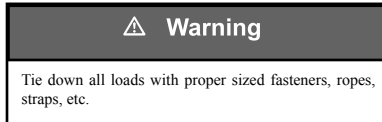

#### **16.2.1. Loading Cargo (Enclosed Trailer)**

Couple the trailer to the tow vehicle before loading. This is essential for the bumper pull because the tongue of the trailer can rise during loading before the cargo can be properly distributed. To measure the tongue weight, you will have to uncouple the trailer after it is loaded.

Do not transport people, containers of hazardous substances, cans or containers of flammable substances. However, fuel in the tank of an off-road vehicle, or a car or motorcycle, etc., may be carried inside of your enclosed cargo trailer.

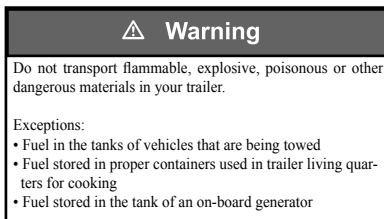
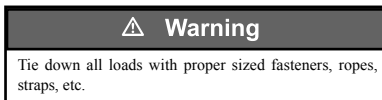

## Loading the Trailer

---

### 16.2.1.1. Loading the Enclosed Trailer

Enclosed trailers may be fitted with a drop ramp door. The weight of the drop ramp door is partially held by a spring and/or cable counterbalance assembly. If this assembly is out of adjustment or worn out, it will not provide the expected assistance for slow and careful lowering and raising of the ramp.

#### Warning

A spring and/or cable counterbalance can break, if incorrectly adjusted.

Inspect the cable and cable ends each time the door is operated.

Do not attempt to service the counterbalance. Take the trailer to your dealer for service.

- ◆ Carefully lower the drop ramp to the ground.
- ◆ Load the cargo up the drop ramp and into the trailer. If the trailer has living quarters, the cargo area of your trailer may have ventilation openings near the floor. Do not block these ventilation openings. These openings are provided to exhaust potentially deadly fumes.

#### Warning

Do not block access to ventilation ports hazardous fumes can accumulate.

- ◆ Secure the cargo to the trailer using appropriate straps, chains and tensioning devices.
- ◆ Close the drop ramp door and secure the trailer door catch using a linchpin or other locking device so that the catch and door cannot open while the trailer is being towed.

#### Warning

Always secure the door latch after closing. Place a linchpin in the catch.

### 16.2.2. Loading Horses (Horse Trailer)

Couple the trailer to the tow vehicle before loading. This is essential for the bumper pull trailer because the tongue of a bumper pull trailer can rise during loading before the cargo can be properly distributed.

The cargo-carrying portion of a horse trailer is designed only for carrying horses. Do not transport people, livestock, containers of hazardous substances, or containers of flammable substances.

#### Warning

Do not transport people inside the trailer, even if it has living quarters.

## Loading the Trailer

---

Before loading a horse in your trailer, inspect the interior of the trailer. The interior of the trailer must be smooth, and have no protruding objects. There should be no loose objects that could move about and startle or injure the horse. Check the walls, floor, dividers, etc., for loose and broken parts, welds, hinges, etc.

### 16.2.2.1. Preparing the Horse Trailer for Loading

Open windows and vents to provide ventilation. Consider the weather and transport conditions (i.e. on warm sunny days, maximum ventilation is required). Do not carry a horse without providing ventilation, even in coldest weather. Ventilation is critical for the well being of your horses.

Know your horses and adjust ventilation for your horses' comfort.

Be sure pivoting window latches are in a flush position, so they do not present any protrusions that can injure your horse.

Tighten any loose or protruding screws in the walls. Remove or secure loose objects, (i.e. butt bars, saddles, tack and equipment) so that items will not move during towing.

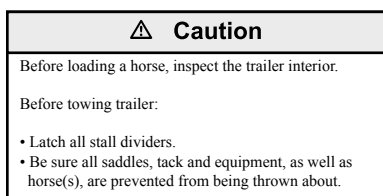

### 16.2.2.2. Loading the Horse Trailer

The trailering of horses introduces many variables that are not present in the trailering of non-living cargo. Horses are prone to take flight when they feel threatened or pain. In the confines of a trailer, the flight response can cause serious injury or death to a human handler. Even experienced and docile horses can be frightened.

1. Horses must be slowly acclimated to trailering. Be sure the horse's first trips are short trips, so you can gauge its reaction. Some will take to the experience easily, others will strongly protest. You must act according to your horse's demeanor.
2. Open all stall dividers, spring tension will hold them in their OPEN (against the wall) position.
3. If the trailer has living quarters, close and lock the door between the living quarters and the horse area.
4. If the trailer is fitted with a drop ramp, carefully lower it to the ground.
5. If your trailer is fitted with swinging loading doors, open them fully and fasten them against the side of the trailer using the door holdbacks.
6. Lead the horse into the trailer by a halter or lead rope. If the horse shows any signs of distress, stop loading, and calm the horse.

## Loading the Trailer

---

### Warning

Improper weight distribution of the horses in the trailer will result in an unstable trailer.

Always load the first horse into the forward-most stall.

7. Tie the horse to the trailer interior by fastening the quick connect or tying the lead rope to the tie ring, or other facility provided on the trailer wall for attachment of the lead rope. A rule of thumb is to leave about 18 inches of free rope between the attachment point on the trailer and the horse. The layout of the horse trailer has been designed to safely contain your horse. The trailer is equipped with stall dividers and tie rings to secure the horse. Restraining a horse without using a combination of a tie-strap and stall divider may result in serious injury or death to the horse.

Close and lock the stall divider.

If additional horses are to be loaded, repeat steps 5-7 above for each horse lead the horse, secure the horse, close and latch the stall divider.

After the last horse has been loaded, latch any unused dividers in the CLOSED (across the trailer) position.

Double check that each horse is tied to the trailer and each stall divider is LATCHED in the CLOSED position.

If your trailer is fitted with a butt bar or butt strap to keep the horse away from the door, hook and lock the butt bar in place.

Close the trailer. Remove the door holdbacks and swing the hinged doors to a closed position, or raise the drop ramp.

Secure the trailer door catch with a linchpin or similar device, so that the catch and door cannot open while the trailer is being towed.

If your trailer is fitted with feed doors, close and secure them.

### Warning

Always secure the door latch after closing. Place a linchpin in the catch.

Check the horses after 5 to 10 miles or 10 minutes of towing, and then at least once per hour thereafter. Open a feed door or other access and look for signs of stress, cuts, or injury.

### Warning

Horses may kick when back door are opened. Stay clear when opening back door.

## Loading the Trailer

---

### **16.2.3.Loading Livestock (Livestock Trailer)**

Couple the trailer to the tow vehicle before loading. This is essential for the bumper pull trailer because the tongue of a bumper pull trailer can rise during loading before the cargo can be properly distributed.

The cargo-carrying portion of a livestock trailer is for carrying livestock only. The livestock trailer does not have the equipment required for the safe transport of horses. Do not transport people, containers of hazardous substances, or containers of flammable substances.

 <b>Warning</b>
Do not transport people inside the trailer, even if it has living quarters.

 <b>Warning</b>
Do not transport flammable, explosive, poisonous or other dangerous materials in your trailer.
Exceptions:
<ul style="list-style-type: none"><li>• Fuel in the tanks of vehicles that are being towed</li><li>• Fuel stored in proper containers used in trailer living quarters for cooking</li><li>• Fuel stored in the tank of an on-board generator</li></ul>

#### **16.2.3.1.Preparing the Livestock Trailer for Loading**

Before loading livestock in your livestock trailer, inspect the interior of the trailer. The interior of the trailer must be smooth and have no protruding objects, such as bolts, broken parts of trailer interior, etc. A protruding object can injure your livestock.

- ◆ Tighten any loose or protruding bolts in the walls.
- ◆ Remove or secure loose objects, so no items will move during towing.

 <b>Caution</b>
Inspect the interior of the trailer before loading livestock.
<ul style="list-style-type: none"><li>• All cargo and equipment, besides the livestock, must be prevented from being thrown about before towing trailer.</li></ul>

#### **16.2.3.2.Loading the Livestock Trailer**

The trailering of livestock introduces many variables that are not present in the trailering of non-living cargo. Livestock may resist being loaded into a trailer.

 <b>Warning</b>
Know your animals' temperament before attempting to trailer them.

## Loading the Trailer

---

If the trailer is fitted with a drop ramp, carefully lower it to the ground.

With the trailer in position, open and secure the loading door (either swinging or roll-up). Open and secure the interior gates as necessary.

Guide the livestock into the trailer.

Gate the livestock tightly to keep them from moving or falling during transportation.

Close the loading doors (either swinging or roll-up) and raise the drop ramp.

Secure the trailer door catch with a linchpin or similar device, so that the catch and door cannot open while the trailer is being towed.

# 17. CHECKING THE TRAILER BEFORE AND DURING EACH TOW

---

---

## **17.1 PRE-TOW CHECKLIST**

Before towing, double-check all of these items (not all items listed are standard features):

- Tires, wheels and lug nuts (see the “Major Hazards” section starting on page 2 of this manual)
- Coupler secured and locked (see the “Coupling and Uncoupling the Trailer” section starting on page 19 of this manual)
- Safety chains properly rigged to tow vehicle, not to hitch or ball (see the “Coupling to the Tow Vehicle” chapter starting at page 16 of this manual)
- Test of lights: Tail, Stop, Turn and Backup
- Safety breakaway switch cable fastened to tow vehicle, not to safety chains (see the “Coupling to the Tow Vehicle” chapter starting at page 16 of this manual)
- Cargo properly loaded, balanced and tied down (see the “Loading the Trailer” chapter starting at page 42 of this manual)
- Tongue weight
- Doors and gates latched and secured
- Fire extinguisher
- Flares and reflectors

## **17.2. MAKE REGULAR STOPS**

After each 50 miles, or one hour of towing, stop and check the following items:

- Coupler secured
- Safety chains are fastened and not dragging
- Cargo secured
- Cargo door latched and secured

# 18. BREAKING-IN A NEW TRAILER

---

---

## **18.1. RETIGHTEN LUG NUTS AT START AND EVERY 50 MILES FOR FIRST 200 MILES**

Wheel lugs can shift and settle quickly after being first assembled, and must be checked at start and every 50 miles for first 200 miles. Failure to perform this check may result in a wheel coming loose from the trailer, causing a crash leading to death or serious injury.

**⚠ Warning**

Check lug nuts for tightness on a new trailer or when wheel(s) have been remounted at start and every 50 miles for first 200 miles.

## **18.2. ADJUST BRAKE SHOES AT FIRST 200 MILES**

Brake shoes and drums experience a rapid initial wear. The brakes must be adjusted after the first 200 miles of use, and each 3,000 miles thereafter. Some axles are fitted with a mechanism that will automatically adjust the brake shoes when the trailer is “hard braked” from a forward direction. Read your axle and brake manual to see if your brakes adjust automatically. If you do not have the axle and brake manual, call Sundowner Trailers, Inc. at (800) 654-3879 for a free copy.

A hard stop is used to:

- ⇒ confirm that the brakes work;
- ⇒ confirm that the trailer brakes are properly synchronized with the tow vehicle brakes; and for many braking systems
- ⇒ automatically adjust the brake shoes.

If your trailer is not fitted with automatically adjusting brakes, the brakes will need to be manually adjusted. See section 8.2.5.2 page 67, “Manually Adjusting Brake Shoes,” for instructions.

## **18.3. SYNCHRONIZING THE BRAKE SYSTEMS**

Trailer brakes are designed to work in synchronization with the brakes on the tow vehicle. Do not use either brake system alone to stop the combined tow vehicle and trailer.

When the tow vehicle and trailer braking systems are synchronized, both braking systems contribute to slowing, and the tongue of the trailer will neither dive nor rise sharply.

**⚠ Warning**

Road test the brakes in a safe area at no more than 30 m.p.h. before each tow.

To insure safe brake performance and synchronization, read and follow the axle/brake and the brake controller manufacturers’ instructions. If you do not have these instructions, call Sundowner Trailers, Inc. at (800) 654-3879 for a free copy.



# 19. ACCESSORIES

---

---

This chapter provides some basic information for the safe operation of several accessories. For many accessories, such as generators and LP appliances, the manufacturer of the accessory has also provided instructions. You must read and follow these instructions before using the accessory. If you are uncertain whether you have all of the instructions, call Sundowner Trailers, Inc. at (800) 654-3879 before operating the accessory. The following accessories are described in this section:

- ⇒ Gasoline (or LP) and Diesel Generators
- ⇒ Accessory Battery
- ⇒ “Shore Power” connections which provide power by “plugging the trailer in” to an external source of electrical power
- ⇒ LP Gas Fuel System
- ⇒ Electric-powered Landing Gear

Many accessories introduce the risk of fire. If you have an accessory on your trailer, make sure you have a fire extinguisher charged and ready before operating the accessory. Check the fire extinguisher at least once a month. If the fire extinguisher is discharged, even partially, it must be recharged. Follow the fire extinguisher manufacturer’s instructions for recharging the extinguisher after use.

## **19.1. GASOLINE-POWERED ELECTRIC GENERATORS**

---

If your trailer is equipped with a generator, you must have and follow the generator manufacturer’s instructions. Carbon monoxide gas is present in the exhaust of all gasoline and diesel engines, as well as from other burning fuels such as LP gas and charcoal.

Carbon Monoxide is an odorless gas that can cause death. Be certain exhaust from any running engine or burning fuels can not accumulate in areas where people or animals are likely to be present. Conditions that can redirect exhaust fumes are, for example:

- ◆ Being drawn in by fans or ventilators operated in a trailer;
- ◆ Prevailing wind;
- ◆ Being trapped between adjacent trailers, vehicles or buildings; or
- ◆ Being trapped between or in a snow bank or other materials that can redirect fumes.
- ◆ You must have an operating carbon monoxide detector inside the accommodation spaces of your trailer.

Before starting the generator, check fuels and oil levels. The generator may have to run for two or three minutes before it allows drawing electricity from it. Read the generator instruction manual. If you do not have the generator instruction manual, call Sundowner Trailers, Inc. at (800) 654-3879 for a free copy.

Never exceed the capacity of the generator.

Before turning off the generator, remove the electrical load and allow the engine to run for two or three minutes to cool the generator.

### **19.2.ACCESSORY BATTERY**

Your trailer may be outfitted with an accessory battery that operates lighting, electric jacks, slide-outs or other accessories. An accessory battery may be kept charged either by the tow vehicle or by the generator or shore power.

A disconnect switch may be provided to disconnect the accessory battery when you do not plan to be using the trailer for an extended period, such as seasonal storage. If there is no disconnect switch, then remove the cables from the battery terminals.

The accessory battery must be kept in a charged condition during storage. The battery could freeze and break if it becomes discharged.

### **19.3.SHORE POWER**

Shore power is the delivery of electrical power from another source to a power inlet on your trailer. To connect your trailer to this source, you must have a “shore power” cord, specifically designed for this use. **DO NOT USE AN ORDINARY EXTENSION CORD.** The trailer end of this cord is connected to an electrical box on the trailer, sometimes referred to as a “motor base.” This box contains circuit breakers and/or fuses and may include a power converter to change the shore power (usually 110 volts alternating current) into 12 volts direct current.

Never leave an electrical cord accessible to animals or small children.

Do not assume that a shore power supply is correctly wired. Shore power may have incorrect polarity or not have the safety ground. Before connecting your trailer, test shore power by using a polarity and ground tester which can be purchased at any electronic store.

If you have shore power, your trailer may be fitted with Ground-Fault Interrupting outlets (GFI). If you have GFI protection, you must periodically test the outlets by pressing the “TEST” button that is located on the GFI-equipped outlet.

#### **Warning**

- Always use an electrical cord specifically designed for shore power connection. Never use an ordinary extension cord.
- Always connect the electrical cord to a grounded source of shore power.
- Do not remove the “third prong” from the shore power plug.
- Connect only to a source of proper voltage.
- Make certain polarity is correct.
- Do not overload electrical circuits.
- Always replace fuses or circuit breakers with correct rating.

## **19.4. LP GAS FUEL SYSTEM**

LP gas systems are installed to operate a variety of appliances, such as stoves, refrigerators, heating units and electrical generators. The exhaust fumes from burning LP gas contain carbon monoxide. Carbon monoxide gas is odorless and can cause death or serious brain injury if inhaled. The exhaust from LP appliances must be directed to the outdoors and clear of your animals. You must have an operating carbon monoxide detector in the accommodation space of your trailer.

 <b>Danger</b>
Make certain the exhaust from LP appliances is directed to the outdoors.
Have a working carbon monoxide detector in the accommodation spaces of your trailer before operating any LP gas appliance.
Do not operate portable grills or stoves inside the trailer.

When used for the first time, or after a period of storage, the LP gas lines will be full of air and must be purged of air, before the appliances will stay lit. Have the LP gas lines purged by your trailer dealer, or an LP gas dealer.

An LP gas system is designed to operate with a supply of LP gas only, NOT natural gas. A natural gas supply is unsafe for the system's pressure regulation devices.

 <b>Warning</b>
Only connect an LP gas system to a supply of LP gas, NOT natural gas.
Do not store LP gas tanks inside the trailer.
Only fill an LP gas tank 80% full.
Only fill the tank with LP gas (butane or propane).
Overfilled tanks can release gas and cause an explosion.

Keep the shutoff valve on your LP gas tank closed at all times, except when you are operating an LP gas appliance. Before opening the LP shutoff valve, turn off all LP gas appliances. If an appliance is on when you open the shutoff valve, LP gas will accumulate in the trailer, which can result in an explosion.

Do not use a wrench to open or close the shutoff valve. If the shutoff does not completely stop the flow of LP gas when it is hand-tightened, replace the shutoff valve.

LP gas leaks can result in fire or an explosion. If your trailer is equipped with an LP gas system, it must also be equipped with an LP gas detector. The LP gas detector will be

located near the floor to detect the heavier-than-air LP gas. If a leak is suspected, use a soapy water solution to search for the leak. Do not use a solution that contains ammonia or chlorine (common in window and other household cleaning compounds) because those chemicals will cause LP piping corrosion.

### Warning

If LP gas is detected (by smell or by the LP gas detector):

- Do not touch electrical switches
- Extinguish flames and pilot lights
- Open doors for ventilation
- Shut off LP gas supply at the LP tank
- Leave the area until odor clears

Correct the source of LP gas leakage before using LP appliances.

Do not use a flame to locate the source of an LP gas leak.

LP gas is either propane or butane that is compressed into liquid form. LP gas must be completely vaporized before being burned. Butane gas will not operate if the outside temperature is below 32 degrees Fahrenheit.

### Notice

Use Butane only when the temperature is above freezing (32 degrees F).

Propane gas will operate at temperatures as low as minus 44 degrees Fahrenheit (-44 F).

Keep the regulator for the LP gas system (located near the LP gas tank) covered with a guard to protect it from road debris.

LP gas is prohibited on some roadways, bridges and tunnels. Check a map and with Departments of Transportation (or with the AAA) for travel routes that do not have such restrictions.

### **19.4.1. LP Gas System Troubleshooting**

- ◆ Having liquid “gas” at your appliance is an indication that the LP gas tank is overfilled, or that the temperature is too cold.
- ◆ If your LP gas appliances do not stay lit, it might be because your LP gas system is contaminated with air or moisture. Many LP gas vendors have facilities to purge the air from an LP gas system.
- ◆ **If your LP gas system is not providing gas, even when the shutoff valve is open, it might be because the LP gas regulator has frozen water in it.**

### Warning

Never use a flame, heat lamp or hair dryer to thaw an LP gas regulator. Use an incandescent light bulb. Do not remove the regulator cover or attempt to service the LP gas regulator.

### **19.5.ELECTRIC-POWERED LANDING GEAR**

The landing gear (also known as the jack) on your trailer may be powered with an electric motor. The landing gear is operated up or down using controls located near the landing gear.

If the motor does not operate, such as when the battery is fully discharged, the landing gear can be operated manually.

### **19.6.TRAILER TOP HAYRACKS OR PLATFORMS**

If your trailer is equipped with an optional hayrack, care should be exercised when loading. Side rails are not intended for occupancy safety railing and as designed are not capable of preventing an accidental fall. Anytime you are on top of the trailer extreme care should be taken to maintain proper footing and balance and use any necessary means to prevent an accidental fall. Do not stand, sit or occupy while trailer is in motion. Make sure trailer is unhooked from tow vehicle and wheels are chocked before mounting hayrack. Make sure cargo is safely and properly tied down before moving trailer.

If your trailer is equipped with an optional observation platform or deck it should be equipped with fold down safety railing. Before occupying, safety railing must be raised and in place to prevent accidental fall. Be sure and observe any and all warnings and weight limitations for platform and railing. Do Not stand, sit or occupy while trailer is in motion. Make sure trailer is unhooked from tow vehicle and wheels are chocked before mounting platform and never move trailer with safety railing raised. If platform is used for storage, make sure cargo is safely and properly tied down before moving trailer.

### **19.7.ELECTRIC/HYDRAULIC BRAKES**

 **Warning**

Only use the supplied brake controller with the Titan Brake Rite electric/hydraulic brake system.

Use of other brands or models of brake controllers with the supplied brake system may cause damage to the brake controller or defective braking.

## **20. SUNDOWNER TRAILER WARRANTY**

### **20.1. Warranty**

For specific information regarding warranty see Warranty Statement Information form provided to you by dealer at time of purchase. Please be certain you or your dealer have completed the Warranty Statement Form and sent it to our office. The Warranty Statement Form must be completed and returned to Sundowner within ten (10) days from date of sale.

**How to Get Service:** Contact any Sundowner Dealer in your area or contact Sundowner at 800-654-3879.

**What To Do If You Are Not Satisfied With Service:** In the unlikely event that you feel our response to warranty service request is not satisfactory, Sundowner offers you an opportunity to air your complaint to an impartial dispute-handling organization. The paragraph below explains how this works.

If you believe your dealer and Sundowner have not performed as stated in this warranty, you may submit a claim to the American Arbitration Association (AAA). The claim or Arbitration may be initiated through ordinary correspondence to the American Arbitration Association, 13455 Noel Rd. Suite 1750, Dallas Texas 75240 provided that all of the essential information is included. Any controversy or claim arising out of or relating to this warranty, or the breach thereof, shall be settled by mandatory arbitration administered by the American Arbitration Association (AAA) under its Commercial Arbitration Rules, and judgment on the award rendered by the arbitrator(s) may be entered in any court having jurisdiction thereof. The arbitration shall occur at location determined by the AAA unless the consumer requests a telephonic hearing.

The AAA will supply the form, or a Submission to Dispute Resolution form, free of charge on request. These forms and addresses can also be obtained through the Association's Web site located at [www.adr.org](http://www.adr.org). You may not file suit against Sundowner under the Magnuson-Moss Warranty Act until your claim has been submitted to the AAA for arbitration and a decision has been reached, or you have waited for a decision in excess of a period time set forth by the AAA, whichever comes first.

**How State Law Applies:** This warranty gives you specific legal rights, and you may also have other rights which vary from state to state.

### **20.2. IMPORTANT:**

INFORMATION PUBLISHED IN THIS OWNER'S MANUAL IS ACCURATE, TO THE BEST KNOWLEDGE OF SUNDOWNER TRAILERS, INC.; HOWEVER, DUE TO THE VAST NUMBER OF MODELS AND TYPES OF SUNDOWNER TRAILERS, IT IS NECESSARY FOR SUNDOWNER TO USE MANY DIFFERENT VENDORS OF RAW MATERIAL PRODUCTS. SUNDOWNER RESERVES THE RIGHT TO CHANGE OR ALTER RAW MATERIAL PRODUCTS, SPECIFICATIONS OR RECOMMENDATIONS PERTAINING TO MAINTENANCE AND SERVICE. THE MAINTENANCE AND SERVICE RECOMMENDATIONS SET FORTH HEREIN MAY VARY, DUE TO YOUR

SPECIFIC NEEDS AND USES. SUNDOWNER RESERVES THE RIGHT TO ALTER, CHANGE, IMPROVE, UPDATE OR DISCONTINUE CERTAIN LINES OR MODELS, ETC., WITHOUT ANY OBLIGATION WHATSOEVER TO FORMER PURCHASERS OF LIKE PRODUCTS. ALSO, SPECIFIC SUPPLIERS OF COMPONENT PARTS TO SUNDOWNER TRAILERS, INC. MAY SUGGEST OR REQUIRE DIFFERENT MAINTENANCE AND SERVICE OF SPECIFIC COMPONENT PARTS. SHOULD YOU HAVE CONCERNS OR QUESTIONS REGARDING THE SERVICING OR MAINTENANCE OF YOUR SUNDOWNER TRAILER, PLEASE CONTACT YOUR LOCAL DEALER OR CALL SUNDOWNER TRAILERS, INC. AT (800) 654-3879 TO SPEAK WITH THE CUSTOMER SERVICE REPRESENTATIVE.

## **20.3. SERVICE & WARRANTY**

### **20.3.1 Procedures**

Building a good product alone does not, in itself, guarantee success. Customer satisfaction and service are two required ingredients in any successful organization or company. We are very interested in your satisfaction and feedback as we continue to improve our product and service.

Realizing that questions and problems will arise, we have established the following steps in an effort to enlist your assistance. Following the steps outlined below will result in the fastest and most efficient resolution of your concerns.

- 1.Contact your dealer's service department for an appointment. Work with the service department in correcting your problem.
- 2.Should you fail in your attempt to have your problem solved, contact your dealer's General manager or the owner of the dealership.
- 3.If your problem still remains unresolved, contact:

Sundowner Trailers, Inc.  
(Customer Service Department)  
9805 OK Hwy 48 South  
Coleman, OK 73432  
(800) 438-4294

Please have the serial number of your trailer handy whenever you call regarding service. Please keep in mind the role of your dealer whenever you require service—he is there to serve you. If you should require service when traveling, contact the factory and we will refer you to a nearby dealer who may assist you.

### **20.3.2 Parts**

Parts are available at most Sundowner trailer dealerships or your dealer will order parts for you as needed. Should you be unable to find a dealer in your local area, contact the Customer Service Department listed above and we will assist you in providing parts through an authorized dealer.

### **20.3.3 Owner's Responsibility**

It is your responsibility to properly maintain your new trailer and to be observant to any possible problems in warranty or otherwise. Negligence is not covered by your warranty. Your trailer should be checked visually before leaving on a trip—especially an extended trip. Regular maintenance is important and will, many times, save the frustration of a breakdown.

If warranty service is required while traveling, contact the Sundowner Customer Service Department and you will be directed to an appropriate facility. To have warranty service provided at a non-authorized service center, there must be prior approval. Any unauthorized repairs will void the warranty on your trailer.

The return of defective parts is required for warranty coverage, should repairs be made at either an authorized or non-authorized service center. The returned parts are subject to approval by the Sundowner Trailers, Inc. warranty administrator before reimbursement can be tendered.

Please keep your owner's manual, service center lists for separately warranted products, your copy of the Sundowner Trailers, Inc. "Limited Warranty" and any other related papers in your trailer.

#### **20.4.REPORTING SAFETY DEFECTS**

If you believe that your vehicle has a defect that could cause a crash or could cause injury or death, you should immediately inform the National Highway Traffic Safety Administration, (NHTSA) in addition to notifying Sundowner Trailers Inc.

If NHTSA receives similar complaints, it may open an investigation, and if it finds that a safety defect exists in a group of vehicles, it may order a recall and remedy campaign. However, NHTSA cannot become involved in individual problems between you, your dealer, or Sundowner Trailers Inc.

To contact NHTSA, you may either call the Vehicle Safety Hotline toll-free at 1-888-327-4236 (TTY: 1-800-424-9133), or go to <http://www.safercar.gov>; or write to:

Administrator  
NHTSA  
1200 New Jersey Avenue S.E.  
Washington, DC 20390

You can also obtain other information about motor vehicle safety from <http://www.safercar.gov>.









# 21. INSPECTION SERVICE & MAINTENANCE

## 21.1.INSPECTION, SERVICE & MAINTENANCE SUMMARY CHARTS

You must inspect, maintain and service your trailer regularly to insure safe and reliable operation. If you cannot or are unsure how to perform the items listed here, have your dealer do them. Note: In addition to this manual, also check the relevant component manufacturer's manual.

Inspection and Service before Each Use		
Item	Inspection / Service	Manual Section Reference
Breakaway Brakes > Electric > Hydraulic	Check operation Check fluid level	Sections 15.2.1.5, 15.2.2.4 & 15.2.3.2 Section 21.2.5.4
Breakaway Battery	Fully charged, connections clean	Sections 15.2.1.5, 15.2.2.4 & 15.2.3.2 Section 21.2.5.3.A.(I)
Brakes, all types	Check operation	Section 18.3
Shoes and Drums	Adjust	Section 18.2 & 21.2.5.2
Brakes, Hydraulic - Vacuum Actuated	Check gauge for proper vacuum of 18 In. Hg. (inches of mercury)	Section 21.2.5.4.A
Coupler and Hitch Ball	Check locking device & replace	Section 21.2.6.1
Gooseneck Ball	Check for cracks, pits, and flats. Replace w/ball & coupler having trailer GVW Rating.  Grease.  Check locking device & replace when worn.	Section 15.2.2.1  Section 15.2.2.1 Section 21.2.6.2
Fifth Wheel & Kingpin	Check for cracks,  Grease.  Check locking device & replace when worn.	Section 15.2.3.1 Section 15.2.3.1 Section 15.2.3.1 & 21.2.6.3
Safety Chain(s) & Hooks	Check for wear and damage	Sections 15.2.1.4 & 15.2.2.3
Tires	Check tire pressure when cold. Inflate as needed.	Sections 6, 7, 17.1 & 21.2.11
Wheels - Lug Nuts (Bolts) & Hub	Check for tightness  Tighten. For new and remounted wheels, check torque after first 10, 25 & 50 miles of driving and after any impact	Section 17.1 Sections 18.1 & 21.2.14

Inspection and Service each 3 months or 3,000 Miles		
Item	Inspection / Service	Manual Section Reference
Structure > Rubber mats and floor > Hinges, Doors and dividers	Remove mats. Wash both sides. Wash floor  Inspect. Repair or replace damaged, worn or broken parts	Section 21.2.2  Sections 16.2.3.1 & 21.2.2

Inspection and Service each 6 months or 6,000 Miles		
Item	Inspection / Service	Manual Section Reference
Tires	Rotate @ 5,000 miles	Section 21.2.11
Brakes, electric > Magnets > Controller (in tow vehicle)	Check wear and current draw  Check power output (amperage) and modulation	Section 21.2.5.3.C Section 21.2.5.3.B See Controller Mfr's Manual
Structure > Roof Vents > Windows	Clean dirt buildup, lubricate hinges and slides	Section 21.2.2
Tires	Inspect tread and sidewalls thoroughly.  Replace tire when treads are worn, when sidewall has a bulge, or sidewall is worn	Section 21.2.11  Section 21.2.11

Inspection and Service each Year or 12,000 Miles		
Item	Inspection / Service	Manual Section Reference
Brakes, all types > Shoes and drums	Check for scoring and wear. Replace per manufacturer's specifications	Section 21.2.5.1 See Brake Mfr's Manual
Jack, Drop-leg	Grease gears at top	See Jack Mfr's Manual
Structure > Frame members > Welds > Slide-out	Inspect all frame members, bolts & rivets. Repair or replace damaged, worn or broken parts.  Inspect all welds. Repair as needed.  Clean dirt build-up. Lubricate slides, shafts and gears	Section 21.2.1  Section 21.2.2.2 Section 21.2.4
Wheels > SEALED Bearings (Hubs)  > UNSEALED Bearings (Hubs)  > Rims	Check and confirm free running. Replace if not (sealed bearings are not serviceable)  Disassemble/inspect/assemble and repack. Replace promptly if immersed in water.  Inspect for cracks & dents. Replace as needed.	Section 21.2.13  Section 21.2.13.1 See Axle Mfr's Manual Section 21.2.12
Structure > Axle Attachment Bolts	Check BY DEALER	Section 21.2.1

## **21.2.INSPECTION AND SERVICE INSTRUCTIONS**

### **21.2.1. Axle Bolts, Frame, Suspension, & Structure**

**⚠ Warning**

Have trailer professionally inspected annually and after any impact.

To perform many of the inspection and maintenance activities, you must jack up the trailer. “Jacking Points for All Trailers” figure below indicates the general areas where jacks and jack stands may be applied.

When jacking and using jack stands, place them so as to clear wiring, brake lines, and suspension parts (springs, torsion bars, etc.). Place jacks and jack stands inside of the perimeter strip on the supporting structure to which the axles are attached.



**⚠ Warning**

Never crawl under your trailer unless it is on firm and level ground and resting on properly placed and secured jack stands.

**⚠ Danger**

If your trailer is equipped with Air Ride Suspension never attempt to adjust or work on suspension without jack stands under trailer.

### **21.2.2.Trailer Structure**

Because the trailer floor receives the most abuse, it will most likely corrode before any other part of the structure. This is particularly true for horse and livestock trailers, having floors subjected to urine and manure. The urine and manure are corrosive to the aluminum flooring and other structural parts of the trailer.

Remove the rubber mats from the floor of the trailer, and wash them at least every three months. Using a power washer and a detergent solution, wash both sides of the rubber mat, as well as, the floor and walls of the trailer. Rinse the rubber mat, the trailer floor and walls. Be sure the rubber mat and trailer floor are completely dry before replacing the rubber mat.

#### **21.2.2.1.Fasteners and Frame Members**

Inspect all of the fasteners and structural frame members for bending and other damage, cracks, or failure. Repair or replace any damaged fastener and repair the frame member. If you have any questions about the condition or method of repair of fasteners or frame members, get the recommendation of, or have the repair done by your dealer.

The various fastener types used on your trailer are:

- ⇒ Bolts, which are used mainly for attaching door and gate hinges to the trailer body; and
- ⇒ Huck Bolts may be at various locations on the sub-frame (see “Typical Huck Bolt Locations” figure below). Huck bolts are not user serviceable. If you detect a loose huck bolt fastener, do not tow the trailer. Call your dealer for instructions.



Appearance of a Huck Bolt  
Typical Huck Bolt Locations

### **21.2.2.2.Welds**

All welds can crack or fail when subjected to heavy loads or movement of cargo that was not properly tied to prevent movement. Any time that you know or suspect that the trailer has been subjected to heavy loads or movement of cargo, immediately inspect the welds and fasteners for damage. To prevent severe damage to your trailer, inspect all of the welds for cracks or failure at least once a year.

### **21.2.3.Drop Ramp Torsion Springs**

If your trailer has a drop-ramp door, the weight of the door may be partially held by a torsion spring and/or a cable. Stand to the side when opening the drop ramp. You could be hurt if you are behind the drop ramp and the counterbalance does not work.

Inspect the cable and cable ends regularly for fraying and signs of loosening. If released, a torsion spring can inflict serious injury.

The torsion spring and/or cable are not user serviceable. The torsion spring must be serviced by a person who is trained in torsion spring safety.

### **21.2.4.Slide-Outs**

The optional slide-out facility is fitted with shafts, bushing, gears and sliding members located on the underside of the trailer. These parts are exposed to road grime, water and possible salt spray. Clean and lubricate the moving parts regularly to keep the slide-out from seizing.

Follow the instructions below to clean and lubricate the slide-out mechanism at least once per season, and more frequently if your trailer is operated in dusty or salt-spray environments.

- ◆ Clean the locations where the drive shaft passes through the bushings.
- ◆ Hand pack grease on the gears.
- ◆ Grease the sliding track.

### **21.2.5.Trailer Brakes**

#### **21.2.5.1.Brake Shoes and Drums**

Properly functioning brake shoes and drums are essential to ensure safety. You must have your dealer inspect these components at least once per year or each 12,000 miles.

The brake shoes must be adjusted after the first 200 miles of use, and each 3,000 miles



thereafter. Most axles are fitted with a brake mechanism that will adjust the brakes during a hard stop. Read your axle and brake manual to see how to adjust your brakes. If you do not have this manual, call Sundowner Trailers, Inc. at (800) 654-3879 for a free copy.

### 21.2.5.2. Manually Adjusting Brake Shoes

Some braking systems are not automatically adjusted by hard stopping. These brakes require manual adjustment. The following steps apply to most manually adjustable brakes. Read your axle and brake manual to see how to adjust your brakes. If you do not have this manual, call Sundowner Trailers, Inc. at (800) 654-3879 for a free copy.

1. Jack up the trailer and secure it on adequate capacity jack stands.
2. Be sure the wheel and brake drum rotate freely.
3. Remove the adjusting-hole cover from the adjusting slot on the bottom of the brake backing plate.
4. With a screwdriver or standard adjusting tool, rotate the starwheel of the adjuster assembly to expand the brake shoes. Adjust the brake shoes out until the pressure of the linings against the drum makes the wheel very difficult to turn. Note: Your trailer may be equipped with drop spindle axles. See the axle manual for your axle type. You will need a modified adjusting tool for adjusting the brakes in these axles. With drop spindle axles, a modified adjusting tool with about an 80 degree angle should be used.
5. Rotate the starwheel in the opposite direction until the wheel turns freely with a slight drag.
6. Replace the adjusting-hole cover.
7. Repeat the above procedure on all brakes.
8. Lower the trailer to the ground.

### 21.2.5.3. Brakes, Electric

Two different types of electric brakes may be present on the trailer: an emergency electric breakaway system, which acts only if the trailer comes loose from the hitch and the breakaway pin is pulled; and an electric braking system that acts whenever the brakes of the tow vehicle are applied.

#### **21.2.5.3.A. BREAKAWAY BRAKE**

##### **21.2.5.3.A.(i) BREAKAWAY BATTERY**

This battery supplies the power to operate the trailer brakes if the trailer uncouples from the tow vehicle. Be sure to check, maintain and replace the battery according to the battery manufacturer's instructions.

##### **21.2.5.3.A.(ii) BREAKAWAY SWITCH**

This switch causes the breakaway battery to operate the electric brakes if the trailer uncouples from the tow vehicle.

## Inspection Service and Maintenance

---

The pull cable for the pull pin is connected to the tow vehicle, and the switch is connected to the trailer. To check for proper functioning of the switch, battery and brakes, you must pull the pin from the switch and confirm that the brakes apply to each wheel. You can do this by trying to pull the trailer with the tow vehicle, after pulling the pin. The trailer brakes may not lock, but you will notice that a greater force is needed to pull the trailer.

**⚠ Warning**

Check emergency breakaway brake system BEFORE each tow.

### **21.2.5.3.B. TOW VEHICLE OPERATED ELECTRIC BRAKES**

The electric brakes that operate in conjunction with the tow vehicle brakes must be “synchronized” so that braking is properly distributed to the tow vehicle brakes and the trailer brakes. For proper operation and synchronization, read and follow the axle/brake and the brake controller manufacturers’ instructions. If you do not have these instructions, call Sundowner Trailers, Inc. at (800) 654-3879 for a free copy.

### **21.2.5.3.C. MAGNETS FOR ALL ELECTRIC BRAKES**

To make certain an electrically-operated braking system will function properly, you must have your dealer inspect the magnets at least once a year or each 12,000 miles. See the brake manual for wear and current inspection instructions.

### **21.2.5.4. Brakes, Hydraulic (vacuum, air or electric operated)**

If your trailer has hydraulically-operated brakes, they function the same way the hydraulic brakes do on your tow vehicle. The hydraulic braking system must be inspected by a dealer, at least as often as the brakes on the tow vehicle, but no less than once per year. This inspection includes an assessment of the condition and proper operation of the wheel cylinders, brake shoes, brake drums and hubs.

You must check the fluid level in the master cylinder reservoir at least every three months. If you tow your trailer an average of 1,000 miles per month in a hot and dry environment, you must check the brake fluid level once a month. The brake fluid reservoir is located on the tongue of the trailer or near the gooseneck. Fill with DOT 4 brake fluid.

### **21.2.5.4.A. VACUUM-OPERATED HYDRAULIC**

When towing a trailer, the vacuum gauge, which is located inside the cab of the tow vehicle, must indicate 18 In. Hg. (inches of mercury) or more at all times.

**⚠ Warning**

Vacuum gauge in the tow vehicle must be at or above 18 In. Hg. (inches of mercury) or the brakes may become inoperable.

### **21.2.5.4.B. AIR PRESSURE-OPERATED HYDRAULIC**

Air/hydraulic braking systems are typically used when the tow vehicle has a diesel engine. The tow vehicle has an air compressor that routes the air to an air/hydraulic mechanism, which sends brake fluid to the wheel cylinders.

The air pressure gauge in your tow vehicle indicates the current air pressure. See your tow vehicle manual for the proper air pressure.

### **21.2.5.4.C. ELECTRICAL-OPERATED HYDRAULIC**

Electric/hydraulic braking systems, which are mounted on the trailer, use a small electrically-driven pump to generate hydraulic pressure, which operates the brake cylinders. Like electrical brakes, an electric/hydraulic braking system is operated by an electrical signal from the tow vehicle (See section 6.7 “Electric/Hydraulic Brakes” on page 57).

## **21.2.6. Trailer Connection to Tow Vehicle**

### **21.2.6.1. Coupler and Ball**

The coupler on the trailer connects to the ball attached to the hitch on the tow vehicle. The coupler, ball and hitch transfer the towing forces between the tow vehicle and the trailer. Before each tow, coat the ball with a thin layer of automotive bearing grease to reduce wear and ensure proper operation; and check the locking device that secures the coupler to the ball for proper operation.

See the coupler manufacturer’s manual for other inspection and maintenance activities. If you do not have this manual, call Sundowner Trailers, Inc. at (800) 654-3879 for a free copy.

If you see or feel evidence of wear, such as flat spots, deformations, pitting or corrosion, on the ball or coupler, immediately have your dealer inspect them to determine the proper action to prevent possible failure of the ball and coupler system. All bent or broken coupler parts must be replaced before towing the trailer.

The coupler handle lever must be able to rotate freely and automatically snap into the latched position. Oil the pivot points, sliding surfaces and spring ends with SAE 30W motor oil. Keep the ball pocket and latch mechanism clean because dirt or contamination can prevent proper operation of the latching mechanism.

When replacing a ball, the load rating must match or exceed the GVWR of the trailer.

### 21.2.6.2. Gooseneck

The gooseneck receiver on the trailer connects to a hitch-mounted ball on the towing vehicle. The receiver, ball and hitch, transfer the towing forces between the tow vehicle and the trailer. Before each tow, coat the ball with a thin layer of automotive bearing grease to reduce wear and ensure proper operation; and check the locking device that secures the receiver to the ball for proper operation.

See the gooseneck ball receiver manufacturer's manual for other inspection and maintenance activities. If you do not have a manual for the receiver, call Sundowner Trailers, Inc. at (800) 654-3879 for a free copy.

If you see or can feel evidence of wear, such as flat spots, pitting or corrosion, on the ball or receiver, immediately have your dealer inspect them to determine the proper action to prevent possible failure of the ball and receiver system.

When replacing a ball, the load rating must match or exceed the GVWR of the trailer.

### 21.2.6.3. Fifth Wheel Kingpin

Before each tow, inspect the fifth wheel and kingpin for wear, and coat the contact surface of the fifth wheel plate with water-resistant Lithium-base grease. If you see evidence of wear on the fifth wheel or kingpin, immediately have your dealer inspect them to determine the proper action to prevent failure of the fifth wheel and kingpin system.

See the manual prepared by the manufacturer of the fifth wheel and kingpin for other inspection and maintenance activities. If you do not have this manual, call Sundowner Trailers, Inc. at (800) 654-3879 for a free copy.

### **21.2.7. Landing Leg or Jack**

If a grease fitting is present, you must use a grease gun to lubricate the jack mechanism. Grease the gears in the top of the hand-cranked jacks once a year by removing the top of the jack and pumping or hand packing grease into the gears.

### **21.2.8. Lights and Signals**

Before each tow, check the trailer taillights, stoplights, turn signals and any clearance lights for proper operation.

**21.2.9. Wiring and Lighting Systems**

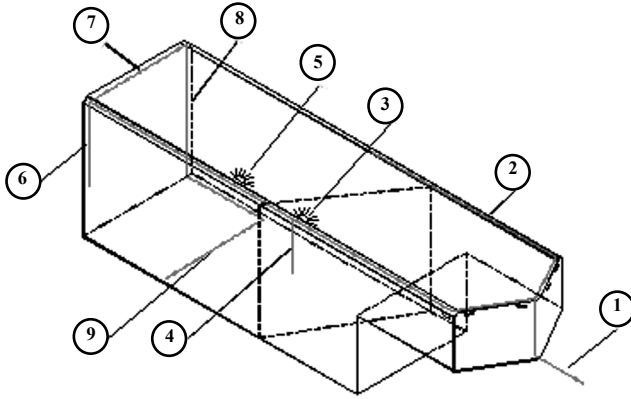

- 1 - 7 Strand w/ Molded Plug
- 2 - Clearance lights street side
- 3 - Light in dress and porch light w/door on curbside
- 4 - Switch leg
- 5 - Light in horse area
- 6 - Tail lights and turn signal
- 7 - Crossover and rear clearance lights
- 8 - Tail lights, turn signal and switch leg
- 9 - Brakes and clearance lights

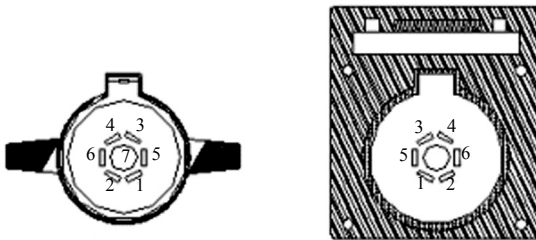

**7-WAY PIN CODES**

Sundowner Wiring Code	
PIN	CIRCUIT FUNCTION
1	Common Ground 1D ga White
2	Electric Brake 10 ga Blue
3	Tail and License 14 ga Green
4	Battery Charge 10 ga Black
5	Left Stop and Turn 14 ga Red
6	Right Stop and Turn 14 ga Brown
7	Center Auxiliary 14 ga Yellow

The connector, commonly referred to as the electrical plug, provides quick and easy connection or disconnection of the trailers electrical system to the tow vehicle. The trailer connector contains the wiring to operate the trailer's brakes, stop lights, turn signals, clearance lights and auxiliary power supply. The trailer-to-tow vehicle ground connection is also found in this connector.

Check trailer and tow vehicle plugs frequently to avoid shorts, possible burned wiring, or for corrosion that can cause a bad connection interfering with the flow of current, which could cause weak or inoperative trailer brakes. Visually inspect the cable for cuts and mashed areas. Periodic application of dielectric lube on the plug, that is sealed to resist corrosion, will ensure good electrical contact.

### **21.2.10. Accessory Battery**

Your trailer may be outfitted with an accessory battery that operates lighting, electric landing gear, slide-outs or other accessories. An accessory battery may be kept charged either by the tow vehicle or by the generator or shore power. See the manual for the accessory battery.

A disconnect switch may be provided to disconnect the accessory battery when you do not plan to be using the trailer for an extended period, such as seasonal storage. If there is no disconnect switch, then remove the cables from the battery terminals.

The accessory battery must be kept in a charged condition during storage. The battery could freeze and break if it becomes discharged.

### **21.2.11. Tires**

Before each tow, be sure the tire pressure is at the value indicated on the sidewall. Tire pressure must be checked while the tire is cold. Do not check the tire pressure immediately after towing the trailer. Allow at least three hours for a tire to cool, if the trailer has been towed for as much as one mile. Replace the tire before towing the trailer if the tire treads have less than 1/16 inch depth or the telltale bands are visible.

A bubble, cut or bulge in a side wall can result in a tire blowout. Inspect both side walls of each tire for any bubble, cut or bulge; and replace a damaged tire before towing the trailer.

#### **Warning**

Worn, damaged or under-inflated tires can cause loss of control.  
Inspect tires before each tow.

### **21.2.12. Wheel Rims**

If the trailer has been struck or impacted on or near the wheels, or if the trailer has struck

a curb, inspect the rims for damage (i.e. being out of round) and replace any damaged wheel. Inspect the wheels for damage every year, even if no obvious impact has occurred.

### **21.2.13. Wheels, Bearings and Lug Nuts**

A loose, worn or damaged wheel bearing is the most common cause of brakes that grab. To check your bearings, jack trailer and check wheels for side-to-side looseness. If the wheels are loose or spin with a wobble, the bearings must be serviced or replaced.

Most trailer axles are built with sealed bearings that are not serviceable. Sealed bearings must be replaced as complete units.

#### **21.2.13.1. Unsealed Bearings (Hubs)**

If your trailer has unsealed axle bearings, they must be inspected and lubricated once a year or every 12,000 miles to insure safe operation of your trailer.

If a trailer wheel bearing is immersed in water, it must be replaced.

If your trailers has not been used for an extended amount of time, have the bearings inspected and packed more frequently at least every six months and prior to use.

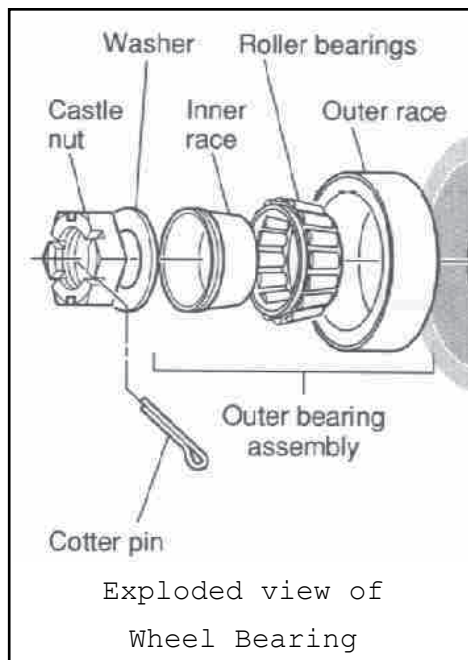

Follow the steps below to disassemble and service the UNSEALED wheel bearings.

- ◆ After removing the grease cap, cotter pin, spindle nut and spindle washer (items 7-10 in “Exploded Wheel Bearing” figure on page 73), remove the hub and drum to inspect the bearings for wear and damage.
- ◆ Replace bearings that have flat spots on rollers, broken roller cages, rust or pitting. Always replace bearings and cups in sets. The inner and outer bearings are to be replaced at the same time.
- ◆ Replace seals that have nicks, tears or wear.
- ◆ Lubricate the bearings with a high quality EP-2 automotive wheel bearing grease.

Every time the wheel hub is removed and the bearings are reassembled, follow the steps below to check the wheel bearings for free running and adjust.

- ◆ Turn the hub slowly, by hand, while tightening the spindle nut, until you can no longer turn the hub by hand.
- ◆ Loosen the spindle nut just until you are able to turn it (the spindle nut) by hand. Do not turn the hub while the spindle nut is loose.
- ◆ Put a new cotter pin through the spindle nut and axle.
- ◆ Check the adjustments. Both the hub and the spindle nut should be able to move freely (the spindle nut motion will be limited by the cotter pin).

### **21.2.14. Lug Nuts (Bolts)**

Lug nuts are prone to loosen right after a wheel is mounted to a hub. When driving on a remounted wheel, check to see if the lug nuts are tight at start and every 50 miles for first 200 miles and before each tow thereafter.

#### **⚠ Warning**

Check lug nuts for tightness on a new trailer or when wheel(s) have been remounted at start and every 50 miles for first 200 miles.

### **21.2.15 Wheel Mounting and Application for Trailer Use**

The following “recommended practices” have been prepared as guidelines by a technical committee composed of representatives from the NATM, RVIA, NMMA, NTEA and a range of steel wheel, aluminum wheel, axle and trailer manufacturers. The Trailer Safety Industry Coalition (TSIC) has tasked this Technical Committee to conduct an investigation into the engineering of the fastening systems for road wheels on trailers and to develop a “recommended practices” document for the assembly of the fastening systems. The Technical Committee provides the guidelines below to communicate these recommended practices for wheel fasteners and the number of wheel separation incidents within the trailer industry.



### 21.2.15.1. Component Guidelines

1. Surfaces of contact on an aluminum wheel (the nut seat and the mounting surface) must be free of paint, contamination and damage. Smooth, clean surfaces provide the most uniform clamping pressure and best retain torque.
2. Surfaces of contact on a steel wheel (the nut seat and the mounting surface) must be free of excessive paint, contamination and damage. Smooth, clean surfaces provide the most uniform clamping pressure and best retain torque.
3. Surfaces of contact on the axle (the flat hub surface and the threaded studs) must be free of excessive paint, oils, grease, contamination and physical damage.
4. Lug nut geometry must match that of the wheel nut seat. The threads and nut seat must be free of paint, oils, grease and other contamination.
5. Stud length must be sufficient that, after mounting the wheel to the hub, the lug nut is engaged to a depth at least equivalent to the diameter of the stud. For example, a lug nut threaded on a ½ inch diameter stud should thread on for a depth of at least ½ inch.
6. If push-through center caps are used they need to fit correctly and flush with the recess in the wheel.

### 21.2.15.2 Assembly Guidelines

Assembly of the wheel onto the hub is a critical, safety-related process. The proper method of assembly and the consistency of the torque applied to wheel fasteners are important factors in ensuring reliability of the fastening system and retention of the wheel to the trailer. The trailer manufacturer, distributor/dealer, and end user must consistently follow proper torquing technique in order to ensure the hub and wheel are properly seated and use caution to prevent anything from interfering with the flat, full designed mating contact of wheel mounting surface and hub. Excess paint, oil and grease must be removed from the fastener contact surfaces (the mounting surfaces, studs, and lugs) or not applied at all. Adherence to the recommended “do’s” and “don’t’s” set out below will minimize the likelihood of fastener torque-loss and wheel separation.

#### **DO’S:**

- Obtain confirmation from each component manufacturer that its component/s is are appropriate for the application, meets the appropriate component guidelines and is/are compatible with the other components in the wheel system.
- Develop and distribute a list or manual of proper assembly and torquing procedures consistent with these guidelines and specific technical information provided by component manufacturers.
- Train appropriate personnel (factory and field) in proper assembly and torquing procedures.
- Insist on consistent, strict adherence to these assembling and torquing procedures.
- Conduct and document regular audits or checks to verify compliance with assembly and torquing procedures
- Investigate and correct any obstruction at the center bore of a wheel, resulting

## Inspection Service and Maintenance

from a poor fit between the ornamental cap and the wheel.

- Remove all oil and grease from threaded fasteners (studs and lugs).
- Mask or shield (cover) all fastener contact surfaces (mounting surfaces and studs) before painting axles, whether for improved cosmetics or for corrosion protection.
- Only use an impact wrench with torque stick as a tool initially to lightly secure the wheel, applying a criss-cross or star pattern (see diagram below).

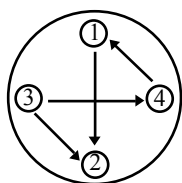

4-Lug Nut Wheel

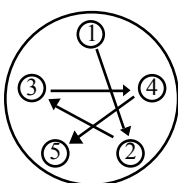

5-Lug Nut Wheel

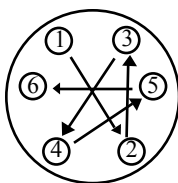

6-Lug Nut Wheel

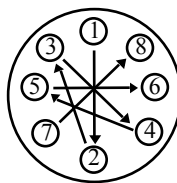

8-Lug Nut Wheel

- Use a calibrated torque wrench to complete the torque fastening process. Applying the same criss-cross or star pattern.
- Retorque periodically during the trailer's initial towing and thereafter in accordance with the component supplier's recommendations.

Lug Nut Torque-Std Wheels		
Axle Rating Pounds	Stud Size	Torque Foot-Pounds
3,500 to 7,000	½ inch	100
8,000	9/16 inch	120 to 140
8,000	5/8 inch spin washer	150
9,000	5/8 inch	175 to 225
10,000	5/8 inch flanged	275 to 325
12,000	¾ inch flanged	375 to 425

**EXCEPTION NOTE:** Anytime manufacturers recommended torque varies from this chart, always use manufacturers recommended torque.

Lug Nut Torque-Aluminum Wheels		
Rim Size	Stud Size	TorqueFoot-Pounds
15 inch (5 or 6 hole)	½ inch	100
16 inch (8 hole)	½ inch	100

- Maintain records of the maintenance and torque checks performed by transporters, noting any loss of torque or any corrective measures taken.
- Investigate any customer claim involving wheel loss.

### **DON'TS:**

- **DON'T** deviate from the component manufacturers' recommendations regarding compatible components without a competent engineering review.
- **DON'T** substitute any component for the components the suppliers have specified without a competent engineering review.
- **DON'T** deviate from the component suppliers, fastener torque specifications, where provided, without a competent engineering review.
- **DON'T** use adhesive products to maintain fastener tension.
- **DON'T** use lubricants or oils on threaded fasteners (studs or lugs) to make applying the torque easier unless assembly specifications require it.
- **DON'T** apply any additional paint on fastener contact surfaces (mounting surfaces hub faces or studs).

### 21.2.15.3. Important Note and Disclaimer

The design, manufacture, assembly, and maintenance of the running gear, wheels, and fastener hardware must be performed under controlled conditions and as part of a system of quality control practices. This system works best when there is constant communication and flow of information between and among component manufacturers, their distributors, trailer manufacturers, transporters, dealers, and end users.

The Trailer Safety Industry Coalition (TSIC) has produced these “recommended practices” as voluntary guidelines to clarify and assist in the proper selection, preparation, assembly, and maintenance of components for steel and aluminum wheel assemblies. These Guidelines do not purport to state that any particular type of component or product should be used in any specific application or that any particular practice, procedure, or methods will not achieve as good or better results, depending upon the particular circumstances involved. The user of these Guidelines, whether manufacturer, distributor, or assembler of these products, has the responsibility to select the proper components for the application intended, perform appropriate process controls, and exercise sound management oversight within its respective operations.





LIVING QUARTER PACKAGE  
OWNER'S MANUAL



## **22. WELCOME TO THE WORLD OF RECREATIONAL VEHICLE OWNERSHIP**

---

We at Sundowner Trailers, Inc. want to welcome you to the wonderful world of Recreational Vehicle use.

Your Sundowner trailer was designed and engineered to offer you many of the comforts you desire. Our desire for all of you is that you enjoy your purchase as much as possible.

We have prepared this manual to help you familiarize yourself more easily with this vehicle and its features. Your Sundowner trailer may have some features not covered in this manual due to possible special orders or additions to the vehicle. You should also have instructions supplied by the manufacturers of the various component parts. Most of these components are covered under their own manufacturers warranties. NOTE: Please fill out all your warranty cards included with these components and send them in.

### **22.1 YOUR FEDERAL CERTIFICATION LABEL**

---

Located on the left front corner of the off-door sidewall is the Federal Certification Label, which gives the maximum weight-carrying capacities of your Sundowner trailer and each axle, designated by the letters “GVWR” and “GAWR”, respectively. This label also contains the “VIN” (Vehicle Identification Number) of your Sundowner trailer and other important information. You should become familiar with the location and contents of this label.

The “GVWR” (Gross Vehicle Weight Rating) is the maximum your trailer should weigh with water, L.P. Gas, food, clothing and other supplies loaded in the Sundowner trailer.

Each axle also has a maximum load-rating capacity referred to as the “Gross Axle Weight Rating” (GAWR). This number is the maximum weight which should be on each axle when the Sundowner trailer is fully loaded.

You can have your Sundowner trailer weighed, both the total weight and the individual axle weights, at most gravel supply yards, feed and grainmills, bulk concrete supply plants or other businesses which normally weigh heavy trucks. You should have the Sundowner trailer weighed any time you think you might be approaching the maximum weights in any area because an overloaded trailer can be very dangerous.

### **22.2 ALTERING OR MODIFYING YOUR SUNDOWNER TRAILER**

---

If you plan on making any alterations to your Sundowner trailer, check with your dealer or call our office before starting. Even something as simple as hanging a picture can cause a drill, screw or nail to penetrate an unseen electrical circuit and cause a very hazardous situation. Additionally, some alterations or modifications to your Sundowner trailer may

## Your Recreational Vehicle

---

void your warranty.

Alterations of the mechanical systems (plumbing, heating, electrical, etc.) should only be performed by qualified technicians who are familiar with recreational vehicle systems because these systems differ from conventional housing systems in several important ways. Your dealer or our factory technicians can advise you regarding the feasibility and available technicians capable of performing alterations you may be considering.



## 23. YOUR TOW VEHICLE

---

It is important to tow your Sundowner trailer with a properly equipped vehicle, with both adequate power and the correct hitch size. Please see your dealer for the correct hitch for your tow vehicle as suggested by the hitch manufacturer. *NOTE: Tandem axle units NEED to travel as level as possible.*

Sundowner trailers require a pickup truck of sufficient towing capacity for the actual weight of a special tow vehicle. If you plan to use a truck which you already have for towing your Sundowner trailer, you should check with your dealer to be sure the truck is properly equipped.

If you are planning to purchase a new tow vehicle, consult your automobile manufacturer for recommendations regarding special equipment available for trailer towing.

*NOTE: Using an over- or under-sized hitch can cause damage to the frame of your Sundowner trailer.*

Sundowner Trailers, Inc. cannot be responsible for the suspension system of the tow vehicle, which is affected by the final hitch height with the trailer attached.

### **23.1 SPECIAL EQUIPMENT**

You may wish to purchase some of the following special equipment with your new tow vehicle or to add these items to your present vehicle:

- Brake Controller
- Side View Mirrors
- Heavy Duty Springs
- Heavy Duty Shock Absorbers
- Special Heavy Duty Tires
- Heavy Duty Flashers
- Electrical Connector
- Heavy Duty Cooling System
- Transmission Cooler
- Fire Extinguisher
- Emergency Flares
- Emergency Triangle Reflectors

Either your recreational vehicle dealer or automotive dealer can advise you on the availability and necessity for alterations or options to equip your tow vehicle for towing the Sundowner trailer.

### **23.2 MIRRORS**

Mirrors for towing your trailer are available in several styles, and may be permanent or temporary mount mirrors. Several types of mirrors are available and may be fender mounted or mounted on a tripod on the door. Door mounted mirrors are not always interchangeable with all models of automobiles, while fender mounted mirrors are. However, some drivers do not like the mirror vision being shifted so far forward with the fender-mounted mirrors and if these mirrors are not mounted properly, they can obstruct the field of vision.

### **23.3 TOWING**

When towing your Sundowner trailer, you need to be aware of the extra weight behind your vehicle. Listed below are pointers which you need to remember when traveling.

1. With the trailer attached, you will have slower acceleration and need more distance to stop the vehicle.
2. Be sure you have enough area at corners when you are turning, as wider turns are necessary.
3. When passing or changing lanes, remember that you need a longer distance to pass.
4. Use your rearview mirrors frequently to observe both your trailer and traffic conditions.
5. When being passed by a large truck or bus, be prepared for displaced air which may cause you to sway slightly.
6. Upon climbing steep, long grades and again descending, remember to use lower gears before it seems necessary. Use your brakes smoothly and evenly. Never “ride” the brakes.
7. Remember to drive more slowly on wet and icy highways to have better control of your vehicles.
8. Keep in mind the additional height of your trailer when driving under roofed areas and around trees.

### **23.4 WHEEL LUGS**

When the wheels were installed on your Sundowner trailer, the lug bolts were tightened to manufacturers specifications. For proper torque and method refer to “Sundowner Trailer, Inc., Owner’s Manual, Section 8.2.14. Lug Nuts (Bolts). Because of the possibilities that these wheel lugs could work loose, it is recommended that you check your wheel lugs after your initial trip or 100 miles, whichever comes first, and weekly thereafter for safety. The wheel lugs should be checked after winter storage, before starting a trip and following braking.

### **23.5 WHEEL BEARINGS**

The wheel bearings in your new trailer are pre-greased. It is recommended that you repack these bearings at 5,000 miles or ever 6 months. Be sure to use only a multi-purpose #1 or #2 good-quality wheel bearing grease. If the bearing or cone (race) become pitted, replace the damaged part immediately.

Carefully feel the wheel center of each wheel during fueling stops. If any wheel feels excessively hot, check the wheel bearings before proceeding.

You can prevent the inconvenience and possible danger of wheel bearing failure if you follow a few simple guidelines:

- Avoid exposure to any water or condensation. These conditions will cause bearing to rust and be damaged.
- Never let bearings run dry.
- Never over pack wheel bearings, especially in the middle of the hub because it will trap heat.

*NOTE: During break-in-period (first 500 miles) your hubs may feel extra warm due to brake shoes setting in with the brake drum.*

### **23.6 TIRES**

The tires on all Sundowner trailers are supplied by companies who specialize in tires for recreational vehicles. These tires are warranted by the tire manufacturer, tested at turnpike speeds and are designed to offer strength and extra mileage in all kinds of weather. The air pressure in each tire should be kept at its recommended pressure. Always check the tires when they are cold, such as before traveling at the beginning of the day. DO NOT release air pressure as tires become hot, if you do, the tires will then be under-inflated when they cool down. It is recommended that the tire pressure be checked at the beginning of each journey to obtain the maximum life of the tires.

*NOTE: Tires are warranted by the manufacturer and are to be serviced and warranted by a service center. They are not to be returned to your dealer or Sundowner Trailers, Inc.*

### **23.7 ELECTRIC BRAKES**

The brakes on your new Sundowner trailer are electrically operated and are integrated into the braking system of your tow vehicle in such a way that equal braking power is distributed to both the trailer and the towing vehicle. Explained below are several components that make up the brake system.

- The battery of your tow vehicle is used as the primary source of power. From the battery, the power is taken to the controller, which should be installed under the dashboard of your tow vehicle. In an open position it breaks the electrical circuit, so no current reaches the brakes. When depressed by hand or by hydraulic pressure (foot pedal) the variable resistor controls the amount of current, which in turn varies the braking action of your trailer.
- The last item in the braking system are the brakes themselves. The brakes are wired in parallel, never in series. Therefore, the brakes are wired to give you assurance of safety and protection.

### **23.8 BREAKAWAY SWITCH**

The breakaway switch is one of the most important parts of your Sundowner trailers electrical brake system. This system will apply the brakes of the Sundowner trailer should it breakaway from the tow vehicle. The very instant a breakaway occurs, the pull-pin which is linked to the tow vehicle is pulled from the switch. The two contacts automatically close to complete the electrical circuit and apply the Sundowner trailer brakes. Sufficient size battery is required to power the break-away switch. *NOTE: Keep the pull-pin plugged in at all times except when hooking-up to the tow vehicle.*

## 24. CONNECTING YOUR TRAILER AND TOW VEHICLE

---

Hooking up your Sundowner trailer is not difficult and becomes even easier with experience. After the first few times, the procedure will become almost automatic.

Gooseneck hitches install in the bed of the tow vehicle. Consult with your dealer regarding the capacity required and proper installation techniques.

The following steps will assist you during hook up:

- The gooseneck ball on your truck should be properly lubricated with heavy-duty grease.
- Your pickup truck should be backed slowly until the ball and the gooseneck on your Sundowner trailer are in proper alignment.
- Release the locking lever by pulling the lever to the “out” position.
- Ease your truck forward slightly and watch for trailer movement to be certain you have proper hookup.
- Once proper hookup is obtained, retract the jacks to the “up” position.
- Connect your electrical cables and check all lights for proper operation.

Also, be sure to check your trailer brakes by operating your brake controller manually.

To unhook your Sundowner trailer from your truck, simply reverse the above steps. Before unhooking, be sure your trailer is level and block the wheels. We cannot overstress proper lubrication of the fifth wheel plate and the locking mechanism since this assembly is manufactured to very close dimensions.

### **24.1 A QUICK TRAILERING SHORT COURSE**

This practice session should be conducted in an open area, such as a shopping center parking lot, when there is minimum traffic (perhaps early Sunday morning). Let’s take a short course in Sundowner trailer towing. You have checked the lights, brakes and wheel lugs; you have adjusted the mirrors; now let’s get acquainted with your rig.

At a slow speed, approximately 5 m.p.h., turn the wheel gently back and forth to get the feel of the rig. Now, experiment with right and left turns, utilizing your turn signals. Stop the Sundowner trailer several times using different combinations of car and Sundowner trailer brakes. Then, test the effect of only the Sundowner trailer brakes on your rig. NOTE: PROPER BRAKE ADJUSTMENT IS IMPORTANT.

After practicing turns and braking, you can try backing up. With patience and a little practice, you’ll be able to maneuver your Sundowner trailer. For instance to move right, move your hand to the right. After your Sundowner trailer has begun to turn, swing the steering wheel again, you can make your Sundowner trailer turn more sharply by moving your hand in the direction of the turn.

---

## Connecting your Trailer and Tow Vehicle

---

If you want to straighten out the Sundowner trailer and tow vehicle, move your hand in the opposite direction.

Before you back into a parking space, it is advisable to get out of the tow vehicle and check for obstacles. With experience, you'll be able to back up using only rear view mirrors.

### **24.2 HIGHWAY DRIVING**

Following a few basic highway driving rules, the beginner or veteran can travel down the highway with all the comfort and convenience of normal traveling. These are a few suggestions that will make towing a trailer easier for you and helpful to other motorists on the highway.

1. Before leaving, check to insure that all lights, brakes, etc. are functioning properly. Also be sure to check the lug bolts for tightness.
2. Use your turn signals well in advance to warn other motorists of turns.
3. Use your mirrors to insure proper clearance before changing lanes or pulling into traffic.
4. Adjust your electric brake controller so the electric brakes take hold before the tow vehicle brakes. Your dealer can assist you in making the proper adjustment.
5. Allow plenty of stopping space for your Sundowner trailer and tow vehicle. There is more weight to slow down, so start slowing down earlier.
6. Because of the greater weight, allow 3 to 4 times more room for passing. Use only enough additional power to pass safely without starting to sway.
7. Steady driving speeds will save gas and still get you where you are going in a reasonable amount of time.
8. When you're driving in the city, it's wise to use a lower gear. Also, watch out for "MUST TURN" lanes, they can be especially troublesome.
9. Use extra care when going uphill and downhill. Accelerate to gain momentum before going uphill. Once at the top, it is wise to downshift to lower gears. This will reduce heating of the brakes.
10. When you see a bump in the road, slow down before reaching it and then release the brakes before hitting the bump.
11. On curves, brake before entering the curve and apply steady power during the curve.
12. Don't apply tow vehicle brakes during extreme sway, a little acceleration is better.

## **25. LOADING YOUR SUNDOWNER TRAILER**

---

---

Your Sundowner trailer has been designed to make maximum use of living and storage space. The equipment and supplies carried while traveling can be done so safely, provided the additional weight is distributed properly.

Proper weight distribution within your Sundowner trailer is an important factor in safety and the efficiency of your trailer brakes, hitch and tow vehicle. **CARE SHOULD BE TAKEN TO AVOID OVERLOADING YOUR TRAILER.**

The total load carrying capacity of your Sundowner trailer is called the Gross Vehicle Weight Rating (GVWR) and is shown on the federal identification tag which is located on the left side near the front. When fully loaded with supplies, water, L.P. Gas, etc., the total weight of your Sundowner trailer must not exceed the stated GVWR.

These basic rules should be followed:

1. Stay within your GVWR (preferably traveling as light as possible).
2. Distribute additional weight as evenly as possible.
3. Store heavy items over the axles and as near the floor as possible.

Heavy items such as canned goods, books and cooking utensils should be placed in the lower storage areas over or slightly ahead of the axle(s). Storage of heavy items on or near the floor will help maintain a lower center of gravity. Use the overhead storage areas for lighter objects such as sleeping bags, blankets, clothing and lightweight bulky items.

## **26. SUNDOWNER TRAILER CONVERSION MAINTENANCE**

### **26.1 TIRE ROTATION**

For maximum mileage, the tires on your Sundowner trailer should be rotated every 4,000 to 5,000 miles. Your dealer can advise you on the preferred sequence of rotation.

### **26.2 WHEEL LUG BOLTS**

*CHECK THE WHEEL LUG BOLTS BEFORE EVERY TRIP*

### **26.3 WHEEL BEARINGS**

Wheel bearings should be greased at least once every 6 months, and more often if you do a lot of trailering. Your dealer can advise you on the intervals appropriate for your level of usage.

Wheel bearings should be checked frequently while traveling by carefully feeling the hubs whenever you stop for fuel. If they feel excessively hot, they should be checked repacked or replaced immediately. Driving with hot wheel bearings can cause the bearings to seize, bringing your trip to an immediate halt. Seized bearings can also cause damage to the axle, necessitating major repairs.

Any time the wheel bearings have become overheated or begin to make a “grinding” noise, they should be replaced. To replace the wheel bearings, lift the trailer with a hydraulic jack and block the axle with jack stands. Remove the axle cap with a screwdriver. Next, remove the cotter pin and lock nut from the axle. Remove and clean the wheel bearings. Check for burns from overheating and replace the wheel bearings if necessary. Apply the recommended wheel bearing grease to the inside of the wheel and to the bearing and replace the bearing. **TIGHTENING OF THE LOCK NUT IS CRITICAL. IF THE LOCK NUT IS TOO LOOSE OR TOO TIGHT, THE WHEEL BEARINGS WILL BE DAMAGED, THEREFORE YOU MUST TIGHTEN THE LOCK NUT FINGER TIGHT, THEN BACK OFF ¼ TURN. THEN REPLACE THE COTTER PIN.** Replace the wheel, remove the jacks and you’re ready to go.

If you are not comfortable with this procedure, your dealer can perform this operation for you.

### **26.4 BRAKE SERVICE AND MAINTENANCE**

High quality electric brakes are matched to your Sundowner trailer’s size and weight to provide optimum braking performance. On tandem trailers, there are electric brakes on all four wheels.

When traveling, observe the following guidelines to save wear and tear on trailer and tow vehicle brakes:



## Sundowner Trailer Conversion Maintenance

---

1. Never ride with your foot on the brake. Apply the brakes with a pumping action so that air circulation around the linings will cool the brakes and brake links.
2. Maintain proper tire inflation pressures for more even braking.
3. Check your brakes often.
4. When traveling downhill, shift to lower gears.
5. Check the breakaway switch periodically. Make sure the activating pin is inserted before you travel.

## 27. OPTIONAL EQUIPMENT FOR CONVENIENCE AND SAFETY

---

There are many items of optional equipment which you should consider adding to your Sundowner trailer. These items include:

- A tool box and assorted tools
- Stabilizing jacks (for minimum)
- Levels
- Wheel blocks
- Leveling ramps
- Water hose
- Tire air gauge
- Spare tire and wheel
- Lug wrench
- Road flares or reflectors
- Hydraulic or screw type jack
- 30 amp electric extension cord
- Fire extinguisher (carried in tow vehicle)
- First aid kit
- Shovel
- Spare fuses (for both interior and exterior systems)
- Flashlight or lantern
- Plastic pails

## 28. TRAVEL TIPS

---

---

As you travel, you will receive “tips” from veteran owners. Here are a few to get you started:

- Remember “Think High and Wide.” Save the top and sides of your Sundowner trailer.
- Taste the water before filling the tanks in an unfamiliar location. Some water contains salt or a Sulphur taste.
- Use manned toll gates.
- Showers can take a lot or a little water. Conserve—take “sea showers.” Wet down, then use the on/off button on the shower head. Turn the water on and rinse.
- Have the oil checked in your tow vehicle every time you fill with gas.
- Check the wheel lugs and wheel bearings frequently.
- Check the radiator water level every day before starting out.
- Keep an eye on the water tank level and the holding tank level. It is a good idea to dump the holding tank at least every two days.
- Conduct an inside tour before starting out. Check for loose objects on the dinette table, sink area, or other areas. An unexpected stop can send loose objects flying.
- Check your rear view mirror frequently to check yourself on how close you are driving toward the centerline.
- Dump sewage only at approved dumping stations.
- When traveling with children, it is helpful to plan their wardrobe for a week. Place each day’s clothing in a plastic bag and label the name and day on the bag.
- Plastic containers with tight fitting caps should be used for storing liquids.
- During peak tour seasons and holidays, it is better to phone ahead and make reservations at the park where you plan to stop.
- Travelers find sleeping bags save work. In cold climates they take less space and are warmer than blankets.
- Some states will not allow you to pass through highway tunnels with L.P. Gas aboard your Sundowner trailer. If your route includes a tunnel, check with the highway patrol, or the department of highways before venturing forth.
- Check the clearances of tunnels, bridges and over passes for clearance.
- Do not leave food or odor-causing materials in your Sundowner trailer for extensive periods of time. Dry damp clothing, hunting gear, etc., before putting it away.
- A fire extinguisher can be your best friend. Make sure it is always charged. Remove and replace it so you are familiar with the operation before an emergency. We recommend recharging the fire extinguisher at least once every two years. This makes a good time to use up the old change by practicing on a campfire. Remember, you should always aim the fire extinguisher at the source of the flames, not the flames themselves.

### **28.1 EQUIPPING YOUR SUNDOWNER TRAILER FOR TRAVEL**

If you start out for a weekend or a long trip in your Sundowner trailer, probably the first thing you will do is load your Sundowner trailer with clothing, food and recreation items. We have provided a suggested list of items below. Remember, it is essential when loading your Sundowner trailer to store heavier items centrally and as low to the floor as possible.

### **28.2 PACKING**

You would prepare carefully for your trip. Start with a checklist of supplies and pack them according to frequency of use on short stops. Don't overload—but remember the essentials. In general, put heavy items low and over the wheels or forward. If you are heading for a rough terrain, use padding in cupboards to hold utensils in place.

Take plastic housekeeping items whenever possible. When you have packed the clothing, children's toys, food and utensils, don't forget the items selected preceding list of optional convenience and safety items.

### **28.3 EQUIPMENT CHECK LIST**

The checklist on the next page has been prepared by experienced campers and is offered to assist you in arriving at your destination with the items you will need. We encourage you use this list until you have developed a custom list for you personal requirements. Using a checklist before every trip will save many aggravations from arriving at the campsite and finding that you forgot an essential item.

# Sample Equipment Check List

## LINENS

- Sleeping bags
- Sheets
- Pillow cases and pillows
- Mattress pads
- Extra blankets
- Laundry bags

## PERSONAL

- Spare eye glasses
- Sun glasses
- Pocket knife
- Sewing kit
- Credit cards
- Traveler's checks
- Money
- Drivers license
- Registration
- Proof of citizenship for Canadian or Mexican crossing
- Camera equipment and film
- Games, toys, coloring books
- Fishing equipment
- Binoculars

## COOKING

- Can opener
- Bottle opener
- Spatula
- Long fork
- Serving spoon
- Skillet
- Pot with cover
- Oven pan
- Plastic shaker
- Mixing bowl and cover
- Aluminum foil
- Wood type matches
- Plastic bags
- Plastic waste baskets
- Sharp knife
- Coffee pot
- Scissors
- Hot pads and mitts
- Paper towels
- Storage dishes
- Spices

## MISCELLANEOUS

- String
- Clothes line
- Fly swatter
- Insect repellent
- Masking tape
- Small barbecue grill

- Charcoal
- Lighter fluid
- Notebooks
- Pencils
- Crayons, marking pens
- History or other "local" books on areas you plan to visit
- Bird watching books
- Boy Scout and/or Girl Scout manuals
- Geology or rock and mineral books
- Stamps for post cards and letters
- Address book
- Wash and Dry napkins

## PET NEEDS

- Leash
- Food
- Dish or bowl

## CLEANING

- Scouring pads
- Cleanser
- Dish soap
- Sponge
- Laundry soap
- Cleaning rags
- Air freshener
- Broom and small hand vacuum cleaner

## BATHROOM

- Hand soap
- Shampoo
- Tooth brushes and paste
- Bath towels that can double as beach towels
- Shower caps
- Toilet kits
- Shaver
- Toilet tissue

## BABY NEEDS

- Porta crib
- Car bed or similar
- Expanding gate with rubber bumpers on end
- Back carrier for your "papoose"

## FOOD

Enough for first couple of days or so—buy as you go. Use plastic, paper, or other disposable containers. Remember seasonings

## CLOTHES

One "good" outfit for each traveler should be included (hang in plastic bag in closet). Remember, it can get cold in the mountains even during the summer. Send for information on the area you are going to visit and plan accordingly, but don't over-pack.

As you travel you will become experienced with what items are necessary and what merely takes up storage space.

### **28.4 HOME SECURITY**

The following tips are offered to assist you in assuring your home will be safe and secure while you are away.

- Leave a key with a trusted neighbor or a relative.
- Store valuables and important papers in a safe place.
- Discontinue newspaper and other deliveries.
- Ask the Post Office to hold mail for you.
- Arrange with the telephone company for discontinued or “vacation service”.
- Arrange care for pets.
- Have your lawn, garden and houseplants cared for.
- Lock all windows and doors securely. Keep shades open for a lived-in look.
- Cover all food to keep out mice and insects.
- Eliminate all fire hazards. Place matches in a metal box or glass jar.
- Store oil, gas and other flammables properly.
- Destroy all newspapers, magazines and oily rags.
- Notify the police you will be gone and ask them to watch your property during regular patrols. Remember to call and thank them when you return.
- Turn all lights off. Utilize an automatic timer if available.
- Unplug all television sets and other electronic equipment that might be damaged if struck by lightning.
- Turn water heater to “pilot” (or off if it is electric).
- Lower your thermostat to 45 degrees or turn off the air conditioner, depending on the season.

### **28.5 INSURANCE**

Upon purchase of your Sundowner trailer, check with your insurance company and/or your dealer for the types of coverage you should carry on your trailer.

## 29. SETTING UP YOUR TRAILER

---

---

Your Sundowner trailer is designed for temporary set up at the campsite of your choice. We recommend selecting a level or nearly level location to be used while camping. There are two (2) reasons to be in a level position. First, your Sundowner trailer is designed to operate in a level position, for both water drainage and especially for the refrigerator. Second, it is more comfortable to live on the level. Should a level site not be available, use short blocks of wood under the lower side wheels to level the Sundowner trailer.

You can comfortably use your Sundowner trailer while still attached to the tow vehicle, providing the campsite is sufficiently level. If you wish to unhook the trailer, proceed as follows:

- Before unhooking the trailer from the tow vehicle, always block the trailer wheels to keep it from moving.
- Raise the front jacks until the trailer is free from the ball.
- Disconnect the electrical cord and breakaway switch cable.
- Move tow vehicle away as needed.
- You are now ready to attach water connections, drain connections and the electrical power cord.
- Turn on the L.P. Gas valves and light any pilots as needed.
- We recommend keeping a window or roof vent open slightly to aid in proper ventilation and help eliminate condensation.

### **29.1 PRIMARY SAFETY CONSIDERATIONS**

Each system in your vehicle is discussed at length later in this manual. The following is a highlight of major safety considerations, which we wish to stress.

#### **29.1.1 Using Your L.P. Gas Systems Safely**

L.P. GAS CAN BE VERY DANGEROUS! L.P. Gas is a very convenient, readily available and economical source of energy. It can be used safely—as evidenced by many thousands of users—with minimal care. If you are not experienced with the use of L.P. Gas, please read all instructions in this manual and those that accompany each appliance in your Sundowner trailer.

When having your L.P. Gas tanks filled, never allow them to be filled above the liquid capacity indicated on the container. An overfilled container may cause the liquid gas to flow through the regulator, causing it to freeze. This can allow excessive gas pressure into the gas piping system. An overfilled container setting in the hot sunlight may also expel excess gas through the relief valve and be susceptible to ignition by an open flame.

Because L.P. gas is heavier than air, leaking gas will tend to flow to a low area sometimes forming a pocket. You can usually detect leaking gas by a smell similar to the odor of garlic or onion. If you should suspect a leak, never strike a match or light an appliance until you

---

## Setting Up Your Trailer

---

check this condition. See this section “Checking for Leaks” on page 136.

Same state laws prohibit travel through tunnels with appliances in operation. When fueling your tow vehicle, it is very important to have your L.P. Gas shut off.

### 29.1.2 Using Your Electrical System Safely

Circuit breakers and fuses are installed to protect electrical circuits from overloading. Do not make unauthorized changes to circuitry or add fixed appliances yourself.

An approved power supply cord sized to accommodate the installed system has been supplied with the vehicle. Always use this cord for hookup to the 120-volt source. If the cord with which our trailer comes equipped is not long enough to reach the park receptacle, use only extension cords rated at least as highly as the installed power cord (30 Ampere/120-Volt).

Grounding is your personal protection from electrical shock. NEVER use any adapter, cheater plug, or extension cord that will break the continuity of the ground. NEVER remove the grounding pin for the convenience of connecting to a non-grounding receptacle.

Correct polarity is necessary to the proper operation of some components in your trailer. Polarity testers are widely available at very reasonable prices. Always check the polarity of your power source prior to connecting your trailer. If the polarity is incorrect or the tester indicates any other problem, notify the park operator and do not attempt to connect your trailer until the problem has been resolved.

### 29.1.3 Emergency Safety

Always carry road flares and/or reflective triangular highway warning devices that can be displayed when necessary. Pull off the roadway as far as possible when changing flats or for other emergency situations. Turn on your vehicular hazard warning flashers when parked along side a roadway, if only for a minute or two.

### 29.1.4 Additional Safety Tips

- Television & Antenna
  - Disconnect the television antenna lead-in during thunderstorms
  - Unplug the television power cord during thunderstorms
- Water system
  - Read the section on water system sanitization
  - Keep all water connections clean
- Warning labels
  - Labels are placed on the trailer in specific places for a purpose, please observe them
- Always keep a serviceable fire extinguisher in an easily accessible location
- Observe the maintenance recommendations elsewhere in this manual



## 30. WINTER CAMPING

---

---

Traveling during the cold winter months can be one of the most exhilarating experiences in all travel. When we speak of cold, we are talking about temperatures of zero to  $-10$  degrees.

There are, of course, certain precautions that must be taken with your Sundowner trailer as would be taken your own home in low temperatures.

- There should be heat in your trailer at all times. However, some states do not allow L.P.G. to be turned on while moving. While traveling in these states it will necessary to take other precautions to prevent freezing of the water and waste drain system (See “Storage and Winterizing”). Additionally, L.P.G. should always be shut off as a safety precaution when gasoline is added to the tow vehicle.
- You must have a plentiful supply of propane gas.
- If your stay is longer than overnight, then endeavor to have shore power available. The battery (fully charged) will not last long in very cold weather. Of course, you can always run the tow vehicle engine to recharge the battery.
- Minimize use of electricity if shore power is not available.
- Leave cabinet doors, under-bed doors, and wardrobe doors slightly open at night to allow circulation of air around all furniture components.

You should remember that low temperatures in combination with high winds cause an equivalent chill temperature much below what the thermometer is reading. For instance, with an outside temperature of zero degrees and the wind velocity of 10 miles per hour, the equivalent chill temperature is minus 20 degrees F. Whenever possible, experienced winter campers try to park their trailer so it heads into prevailing winds. Use trees and other natural barriers as windbreaks. Be sure to check all tires before setting out. There should be plenty of tread left on each one for safety and maximum traction.

It is very important to **GUARD AGAINST EXCESSIVE HUMIDITY** inside your trailer during winter campouts. You are living in a comparatively small area, which means there is not a great volume of air to absorb moisture. When windows and window frames fog up or “sweat,” it means that there is too much moisture in the air. Moisture comes from water vapor, and water vapor is the direct result of water evaporation. Many things such as baths and showers, boiling foods, washing dishes, mopping the floor, washing clothes—even breathing—contribute to evaporation. The inside air can only absorb so much of this moisture before it becomes saturated. At this point, it can hold no more and any additional water vapor condenses back to water in the form of droplets on any available cool solid surface. Temperature has a direct effect on the air’s saturation point. Cold air holds less moisture than warm air. For this reason, the air immediately adjacent to cold outside walls and windows cools down and causes water vapor to condense and form moisture droplets even though warmer inside surfaces are still dry. Condensation can cause many problems, including rotting of wood components and mildew on clothing. Severe condensation can even cause water vapor to form within electrical components, which can be a serious problem.

## Winter Camping

---

THE BEST WAY TO KEEP CONDENSATION UNDER CONTROL is to reduce moisture-producing activities. It is also important to provide adequate ventilation and keep the air circulating as much as possible. Use your exhaust fans to remove moisture before water vapor mixes with the air. Open windows slightly once in a while, while operating fans to bring in drier outside air and aid in overall air circulation. In extremely cold weather, when outside ventilation is not practical, it may be necessary to use a small dehumidifier to aid in reducing condensation.

# 31. YOUR SYSTEMS

---

---

## **31.1 ELECTRICAL SYSTEMS**

Your electrical system is designed to provide power to your built-in appliances and lights from a 120-volt outside source (shore power). This system is identical to the system installed in your home, although it is not as large. On all Sundowner trailer conversions, a 12-volt direct current (D.C.) system is also installed to operate some appliances and lights independent of shore power. A converter, when connected to shore power and by a 12-volt battery installed on the trailer, powers the D.C. system when not connected to shore power. The converter charges the battery when your trailer is connected to shore power and by the tow vehicle alternator when it is connected to the tow vehicle and the tow vehicle engine is running. As with all systems, the electrical equipment has been installed in an approved manner as required by national codes and standards. Remember, the power from the battery is limited. Do not try to operate your trailer for too long on the battery alone. You will find from experience just about how long the battery will last before it needs recharging. Should the battery require replacement, be certain to purchase a “deep cycle” battery of adequate capacity. Your dealer can advise you on the best available options.

## **31.2 CHANGES, MODIFICATIONS AND ADDITIONS**

Your electrical systems have been designed and installed in accordance with the safety requirements of the National Electrical Code. Any changes, additions and/or modifications that might be made after delivery may cause a hazardous condition. Be sure to consult your local authorized dealer for advice concerning changes or additions. Only qualified electrical technicians should be allowed to make any changes or additions to your electrical system. Only approved materials and components suitable for recreational vehicle use should be installed and approved methods of installation should be employed.

**WARNING:** Never replace breakers or fuses with devices of a higher current rating than those installed by Sundowner Trailers, Inc. Over-fusing may cause a fire hazard by overheating the wiring above its temperature rating. Extension cords used in connecting your trailer to the park receptacle should be rated at or above the over-current protection of the main breaker in your breaker panel and as short as possible to prevent overheating. Should an extension cord need to be used, do not permit the unused portion to lie in a coil since this can cause the extension cord and the power cord attached to the trailer to overheat.

## **31.3 12 VOLT D.C. BATTERY SYSTEM**

The 12-volt battery system is designed to power the following equipment in the Sundowner trailer:

- Interior Lights
- Range Exhaust Fan
- Furnace (blower or fan)

- Water Pump
- Power Roof Vent

### 31.3.1 Battery Care and Maintenance:

When camping in out-of-the-way places, your source of electricity will be your storage battery. The battery will supply power for lights and all other accessories. Proper care of the battery is necessary for longer service life. Check the battery charge often. Examine for loose terminals or water loss. You can use the hydrometer at most service stations to check the specific gravity of the battery. For extra long trips, you may wish to install an extra battery for added electrical power.

When your trailer is connected to the tow vehicle without the engine running—and you are not connected to shore power—the 12-volt system can draw current from the tow vehicle battery. With extended use, this can cause the tow vehicle battery to be drained below the level necessary for starting the engine. You can avoid this by either disconnecting the tow vehicle connection before using the 12-volt system or having a battery isolator installed in your tow vehicle.

To clean the battery, remove it from the storage compartment and wash the top with baking soda and water.

Some Sundowner trailers are equipped with a 12-volt receptacle for the operation of 12-volt appliances. Small television sets and electric razors are the most popular 12-volt appliances. However, some appliances require considerable amperage, which may drain your battery and steal needed power from other Sundowner trailer accessories. Make sure to check the amperage draw of appliances and ration your power carefully.

### 31.3.2 Battery Charger:

The converter installed in your Sundowner trailer is the most technologically advanced unit available and has a built-in battery charger. The battery charger will automatically charge the auxiliary battery when the R.V. is connected to a 120-volt A.C. power source. The charger is equipped with an automatic shut-off and will not overcharge your battery.

### 31.3.3 Care of Your Power Converter:

There are several manufacturers' suggestions for maintenance of the heavy-duty power converter installed in your Sundowner trailer.

1. There should be free circulation of air around the power converter. Do not let things pile up around or on the converter.
2. Keep the power converter dry. It is electrical equipment and, hence, susceptible to damage from moisture.

3. Keep the power converter clean as possible.
4. Be careful not to overload circuits.
5. If the converter fails to operate, first check incoming power to make sure 120-volt A.C. is available. Check the plug connection. If there is a clicking noise, the battery may be installed backwards.

The power cord on the power converter should be inspected frequently for cracks, chips or fraying. Make sure the plug ends are corrosion-free and not bent. The plug on the end of the power cord is required by electrical codes and should not be altered or changed.

Please study the instruction manual provided by the manufacturer of the power converter.

### 31.3.4 Running, Tail and Stop Lights:

All exterior running lights meet ICC specifications and have been designed for maximum visibility and highway safety. Before you start on a trip, the exterior lighting system should be checked. Check the turn signals (both directions), the running lights, tail lights and brake lights and ensure at least five or seven lights on the rear of the trailer are operative. This is the minimum number required by federal highway regulations.

These lights are powered by the tow vehicle electrical system and operate in tandem with the tow vehicle lights. For your convenience in connecting to the tow vehicle, the exterior lights are wired in accordance with the following color code:

BLACK-GROUND  
BLUE-BRAKES  
BROWN-RUNNING LIGHTS  
YELLOW-STOP & LEFT TURN  
GREEN-STOP & RIGHT TURN  
BLUE-12-VOLT D.C. SUPPLY  
RED-BRAKES

The connector between the tow vehicle and your trailer may corrode due to exposure to road salt and should be cleaned periodically to insure good electrical contact.

### 31.3.5 Trouble-Shooting Your Living Quarters:

<b>Problem</b>	<b>Check</b>
One light out	Check bulb and socket and clean contacts/check ground
Two or more lights out	Check fuses in converter
No power	Check power cord and/or circuit breakers
Lights dim	Check battery voltage, Check line voltage
Water pump will not run	Check switch, check fuse in converter, loose wire at pump
No outside lights work	Check chassis ground

### **31.4 120-VOLT A.C. SYSTEM**

Every Sundowner Trailers, Inc. conversion is equipped with an alternating current (A.C.) electrical system. The capacity of this system is 120-volt A.C., 30-ampere. There is also a label attached to the exterior of your trailer near the power entrance specifying the capacity of the system installed.

The A.C. system operates from an external 120-volt A.C. power source. When arriving at a campsite, determine whether the site chosen has the appropriate connection available for the A.C. system installed in your trailer. This system operates just like the electrical system in your home and is designed to provide 120-volt A.C. to all the electrical convenience outlets and the optional roof air conditioner. Any appliance used in your home can be used on this system, provided that it does not draw more power than is available.

The 120-volt A.C. system also supplies power to the converter, which converts 120-volts A.C. to 12-volts D.C. The converter automatically disconnects the battery from the 12-volt D.C. system and provides the needed current to run all 12-volt equipment. The battery charger will provide an automatic charge to the battery when the unit is operating on A.C. power.

#### **31.4.1 Connecting to the A.C. Source:**

The “extra pin” on electric plug caps (third pin on 12-volt, 30-ampere power cords) is included with the trailer, however, many still do not understand its purpose or importance in preventing death-dealing shock. Since electrical equipment—including your trailer—seems to work satisfactorily without it, some consider the “extra” pin a nuisance and break it off of 15 amp plugs when they want to plug into obsolete receptacles that will not accommodate it.

Many ask why the trailers are equipped with those big plugs that won't fit into some of the receptacles in older parks and the answer is very simple—to prevent you from plugging them into inappropriate or unsafe receptacles. Owners often make such connections anyway, though this is dangerous and should not be done.

The plug on your Sundowner trailer has been selected to handle the anticipated current draw when connected to an A.C. power supply. The small receptacles found in many older recreational vehicle parks are the same as commonly used in your home and are rated only 15 amps. That “rating” means that if more than 15 amperes is drawn from it, the contact will get hot and eventually burn out—and so will the wire feeding it if it is also rated at 15 amps (No. 14 conductor).

We hope some day all parks will provide proper receptacles for trailers, but the greater expense of wiring the parks for 30-ampere receptacles seems to be holding back such progress. Aside from the nuisance tripping the 15 amp park circuit breakers or fuses and burning out the receptacle contacts, the real problem arises for all the makeshift arrangements devised by owners to connect trailers to inadequate park receptacles. Some of these connections can result in severe injury or death from electrical shock. What is the “extra” pin for? Why is it so important? Very simply, the “extra” pin is a means of connecting the exposed metal

parts of an appliance or recreational vehicle to earth ground to prevent voltage differences between the vehicle and earth that can cause a shock. The National Electrical Code is very explicit in its requirements to assure the connection of “all exposed non-current-carrying metal parts that may become energized” to the grounding conductor—which is thence connected to the “extra” pin. The receptacle for the “extra” pin then must be connected to earth ground (at the power pedestal in the park) in accordance with the National Electrical Code.

According to these standards:

- The metal skin of your trailer must be bonded to the metal frame.
- The frame, water pipes, gas pipes and all other exposed metal parts must be connected to the grounding bus in the distribution panel board (breaker panel).
- The grounding bus is then connected through the green wire in the power supply cord to the “EXTRA” PIN.
- The “EXTRA” PIN in the park receptacle is the connected to earth ground.

With everything connected properly in this grounding circuit, the vehicle is “shock safe” –but it could become very unsafe if the continuity described above is not maintained. Let us examine several possibilities. First, it should be explained there is a difference between “trailer wiring” and “house wiring” and in that the “neutral” current carrying conductor in the house is grounded at the distribution panel board. But not so in the trailer, and there is a good reason. There is a high probability that trailer may be plugged into a park receptacle backwards, reversing the polarity of the “hot” and “neutral” current carrying conductors, thus making the trailer skin electrically “hot” and creating a very real shock hazard.

There are several ways this could happen, all of which would have a 50% chance of making a real killer out of your trailer. Perhaps the most common way is through the use of a two-conductor extension cord to connect the trailer to the park receptacle. A second way would be by using a “cheater plug,” from which the “extra” pin had been removed and last—but probably not the only other way—would be from a replacement plug put on the original power supply cord as a replacement for the plug which was cut off (because it wouldn’t fit the park receptacle).

*WE DO NOT RECOMMEND THE USE OF NON-APPROVED  
ADAPTERS FOR ELECTRICAL HOOKUP*

Even though the neutral conductor is not grounded in a recreational vehicle when it is wired at a factory, it could inadvertently be grounded later on through some appliance or through a puncture in the insulation. Or it may be the hot conductor that shorts to some metal part of the trailer. In either case, without the grounding circuit intact you may never know the difference until you have touched the outside of the vehicle while standing on damp ground.

With the grounding circuit complete, with the “extra” pin properly connected at the park receptacle, any accidental shorting of a hot circuit conductor in the trailer will blow the fuse or trip the circuit breaker in the park circuit, giving a warning that something is wrong. If

the neutral circuit in the trailer should short to the metal skin or frame accidentally, nothing would happen and it would not be dangerous unless the polarity was reversed in some manner as described earlier. In either case, having the grounding circuit complete through the “extra” pin to earth ground in the park wiring system would keep the trailer safe from shock. When absolutely necessary to plug into a receptacle with no provision for the “extra” pin, use an adapter with a pigtail that can be connected to the receptacle box.

In essence, if you make sure your trailer has a proper ground by using the “extra” pin on the electrical plug; you are insuring yourself that you will have a safe camping experience.

### 31.4.2 Circuit Breaker Panel:

All trailers are equipped with an electrical distribution panel, commonly referred to as a circuit breaker panel. You should become familiar with the location of the breaker panel in your trailer. The breaker panel operates just like home circuit breaker panel. When a circuit is overloaded or shorted, the breaker switch will trip. The breaker switch can be manually reset by turning it to the off position and then turning back on. If the breaker continues to trip and you have made certain that the circuit is not overloaded, a qualified electrical repair person should be consulted.

### 31.4.3 G.F.C.I. (Ground Fault Current Interrupter) Device:

This special device, which may be a circuit breaker installed in the breaker panel or a special receptacle installed in the bathroom or exterior receptacle, has been designed to further reduce the possibility of injury caused by an electrical shock.

Ground fault current is the current which would flow through a person who is using or touching an appliance with faulty insulation while at the same time, is in contact with an electrical ground such as a plumbing fixture, wet floor, or earth. The G.F.C.I. device will not protect against short circuits or overloads. The circuit breaker or fuse in the electrical panel, which supplies power to the circuit, provides this protection.

When G.F.C.I. device is tripped, it has interrupted ground fault current caused by such things as faulty insulation or wet wiring inside some appliance or equipment connected to the circuit. The faulty equipment should be repaired before it is used again.

This special device should be tested periodically. Refer to the small instruction booklet supplied with your trailer. This G.F.C.I. device is a requirement to the National Electrical Code and should not be altered or replaced with anything other than another G.F.C.I. device for any reason. A competent electrician must perform any replacement or repair of this device.



## **31.5 LP GAS SYSTEM**

### **31.5.1 Basic Information:**

Most trailers are equipped with an LPG (liquefied petroleum gas) System. LPG is a true gas compressed into liquid form for easy transportation and storage. It is also known as Butane, Propane and Bottle Gas. An on-board storage tank provides gas for cooking, heating or refrigeration. Do not connect your trailer to natural gas.

The LPG System in your Sundowner trailer will normally consist of gas bottle(s), shut-off valves, two-stage pressure regulator, furnace, gas/electric refrigerator, water heater and range. Butane and propane are the two basic fuels used for LPG Systems.

When utilizing LPG appliances at high altitudes, such as mountain campgrounds, the gas burns at a lower temperature. This causes a “cooler” flame and cooking times will be proportionately increased, as will gas consumption of the furnace, water heater, etc. If you are preparing recipes in which cooking time and/or temperature are critical you should consult a good cookbook or seek local advice regarding the proper adjustments for the altitude at which you are camped.

Propane in the gaseous state is heavier than air. If allowed to escape into the atmosphere they will flow to the lowest point in your Sundowner trailer. Propane in its natural state is odorless and tasteless. An odorant is introduced into these gasses so that, in the event of a leak, you should detect a distinct odor.

### **LIQUEFIED PETROLEUM GAS (LPG) IS EXPLOSIVE**

*Utmost care should be exercised to prevent leaks from open valves. If you smell a gas leak, all windows, outside doors and cupboard doors should be opened so that the gas may escape. Let the trailer stand for at least 2 hours. Opening the windows only may not eliminate the danger of explosion. Do not light any appliances or flames of any type.*

### **31.5.2. L.P. Gas Bottle Installation Instructions:**

If your dealer does not install your L.P. Gas containers, follow the simple instructions below:

- Thread the long rod into the base plate.
- Set both bottles in place.
- Place the hold-down bracket over the rod and hook onto both bottles.
- Tighten the wing nut to hold the bracket tight and hold bottles onto the plate.
  - Attach regulator to the bracket.
  - Attach long hose to the regulator and gas manifold.

- Attach both short rubber hoses from the regulator tee to the bottles.

The L.P. Gas tanks mounted on your vehicle are designed to contain L.P. Gas fuel in liquid form under high pressure. As fuel is used, vapor (L.P. Gas) passes from the top of the tank through a dual-stage regulator, which reduces the pressure to approximately 6 ½ ounces per square inch or 11-inch water column. Gas vapor is transferred through the gas distribution lines for appliance use. You must keep the regulator clean and dry.

### 31.5.3. L.P. Gas Regulator Installation:

L.P. Gas regulators must always be installed with the diaphragm vent facing downward. Regulators that are not in compartments have been equipped with a protective cover. Make sure that the regulator vent faces downward and the cover is kept in place to minimize vent blockage, which could result in excessive gas pressure causing fire or explosion.

L.P. Gas systems must be carefully maintained at all times and all safety rules should be carefully observed.

If you travel alternately on wet roads and in freezing weather, be sure your L.P. Gas regulator is protected from road spray. If water enters the vent in the regulator, it may freeze the pressure-controlling diaphragm in the open position and cause container pressure to be applied to the appliance. This is a very hazardous condition.

### 31.5.4. Using the Automatic Changeover Regulator:

When an automatic changeover regulator is installed, both cylinder valves should be open. The regulator assembly has a changeover knob with an arrow. The cylinder to which the arrow points is the “active” cylinder. The other is the “reserve” cylinder. As long as there is fuel in the active cylinder, the indicator on the top of the regulator will show white. When the active cylinder is empty, the regulator will automatically change the “reserve” cylinder and the indicator will change to red.

When you notice the red indicator, turn off the valve of the active cylinder and turn the changeover knob so the arrow points to the “reserve” cylinder, thereby making it the “active” cylinder. The indicator will change back to white as soon as you turn the knob. Disconnect the empty cylinder and have it refilled. When you reconnect it, it then becomes the “reserve” cylinder. By “leap-frogging” the cylinders in the manner, you should always have reserve L.P. Gas available.

### 31.5.5. Check for Gas Leaks:

If your trailer has been in transit for an extended period, check the fuel line connections and appliance valves before and after opening the cylinder valve. A solid line runs from the LPG tank and no connections are made within the walls of the trailer. Therefore, all connections are accessible for checking. Some easily performed tests are outlined below:

Turn off all appliances; turn off the LPG valve and wait approximately three minutes. By putting your ear close to the regulator and turning the tank valve on rapidly, listen for a slight hiss. If you hear a slight hiss there is definitely a leak in the gas line.

Apply soapy water to all points or connection points with the gas turned on and look for telltale bubbles. Do not use soaps that contain ammonia for this test since they could cause corrosion of some piping components.

***Never Use an Open Flame When Testing  
For Leaks in the Gas System***

*WARNING: L.P. Gas containers should never be placed or stored inside the vehicle. L.P. Gas containers are equipped with safety devices that relieve excessive pressure by discharging gas to the atmosphere and could cause a very dangerous situation.*

**31.5.6. Portable Fuel-Burning Equipment:**

WARNING: Portable fuel-burning equipment, including wood and charcoal grills and stoves, must never be used inside the trailer. Use of this equipment inside the trailer may cause fires or asphyxiation.

**31.5.7. Storage of Flammable Substances:**

WARNING: Storage of L.P. Gas containers, gasoline or other flammable liquids inside your vehicle—even for short periods of time—present a risk of fire and/or explosion. All flammable liquids should be stored safely in a well-ventilated area outside your vehicle and in proper containers.

**31.5.8. L.P.G. Warning:**

The following table has been placed in the vehicle near the range area:

**IF YOU SMELL GAS**

1. Extinguish any open flames, pilot lights and all smoking materials.
2. Do not touch electrical switches.
3. Shut off the gas supply at the tank valve(s) or gas supply connection.
4. Open doors and other ventilating openings.
5. Leave area until odor clears.
6. Have the gas system checked and leakage source corrected before using again.

31.5.9. Range Ventilation:

This warning label has been located in the cooking area to remind you to provide an adequate amount of fresh air for combustion. Unlike homes, the amount of oxygen supply is limited due to the size of the recreational vehicle and proper ventilation when using the cooking appliance(s) will avoid danger of asphyxiation. It is especially important that cooking appliances not be used for comfort heating, as the danger of asphyxiation is great when the appliance is used for long periods of time.

**IT IS NOT SAFE TO USE COOKING APPLIANCES  
FOR COMFORT HEATING  
Cooking appliances need fresh air for safe operation.  
BEFORE OPERATION**

1. Open overhead vent or turn on exhaust fan
2. Open window

31.5.10. L.P. Gas Consumption:

L.P. Gas Consumption depends upon individual use of appliances and the length of time operated. Each gallon of L.P. Gas produces about 91500 BTU's (British Thermal Units) of heat energy. Following is a list of typical appliance consumption when used continuously for one hour of operation.

<i>Appliance</i>	<i>Average BTU Consumption per Hour</i>
Each Range Burner	5,200
Furnace	30,000-55,000
Range Oven	7,100
Refrigerator	1,500
Water Heater	9,000-12,200

The actual rated usage of the appliances installed in your trailer can be found on the rating plates attached to each appliance.

31.5.11. Servicing and Filling L.P. Gas Containers:

A warning label has been placed near the L.P. Gas container(s). This label reads:

**DO NOT FILL CONTAINER(S) TO MORE THAN 80% OF CAPACITY**

Overfilling the L.P. Gas container can result in uncontrolled gas flow, which can cause fire or explosions. A properly filled container will contain approximately 80% of its volume as liquid L.P. Gas.

*CAUTION:* Never smoke during filling of L.P. Gas tank, there is a concentration of garlic-like odor that may be mistaken for a gas leak. After changeover to a full tank, the odor will

usually disappear. Over-filled tanks will sometimes expel excess pressure when exposed to direct sunlight or hot temperatures. If this becomes objectionable, remove the tank to a safe area and open the supply line valve to allow excess pressure to escape. Make certain there is no source of ignition in the area. **DO NOT SMOKE WHILE DOING THIS!**

When L.P. Gas containers are filled to the proper level there is available space for safe expansion of the vaporized liquid. Over-filled tanks can cause regulator and appliance malfunction. Handle your L.P. Gas tanks with care. Note that when disconnecting your must turn the wrench in a **CLOCKWISE** direction because the connection utilizes left hand threads. When reconnecting, turn wrench **COUNTER CLOCKWISE**. Tighten only until “snug” and avoid over-tightening.

*HINT:* With dual bottles on your trailer, use only one at a time. Otherwise the gas supply will be drawn equally from both bottles until the supply has been totally exhausted. Using one bottle until it is empty, then using the second bottle will allow you to fill the empty bottle at your convenience without being totally out of L.P. Gas.

***WARNING! L.P. GAS CONTAINERS SHALL NOT BE PLACED OR STORED INSIDE THE VEHICLE. L.P. GAS CONTAINERS ARE EQUIPPED WITH SAFETY DEVICES, WHICH RELIEVE EXCESSIVE PRESSURE BY DISCHARGING GAS TO THE ATMOSPHERE.***

## **32. PLUMBING SYSTEMS**

---

---

### **32.1 FRESH WATER SYSTEM**

Sundowner trailers are equipped with both a demand water supply system and a city water supply system.

### **32.2 DEMAND SYSTEM**

The water pump in your new trailer is a 12-volt D.C. activated demand pump. This pump has been pre-wired for immediate use. Turn the pump switch to the “on” position and water will be pumped throughout the system. When the system is full, the pump will shut off automatically and hold at 30-35 pounds of pressure. It is important that you turn the pump off when traveling, in storage and/or when using the city water hookup. Otherwise the battery may drain needlessly.

Demand water systems feature an electric water pump, a fresh water storage tank and associated piping to deliver fresh water when a faucet is opened. When connected to your 12-volt D.C. power source, the pump will keep a constant pressure in the system, running only when there is a demand for water. The pump will automatically shut off when the demand for water ceases.

#### **32.2.1 Operation:**

- Check level of water in tank.
- Be sure all valves are open and strainers are clean.
- Open all faucets, hot and cold.
- Turn on power to pump and wait for hot water tank and water lines to fill.
- Close each faucet when it starts to deliver a steady stream of water (close cold water first).
- Observe the pump. Check to be sure pump stops soon after closing all faucets.
- Pump is now ready for automatic operation. It will start when a faucet is opened and stop when the faucet is closed.

### **32.3 TROUBLE SHOOTING**

**PROBLEM**—*Pump operates but no water flows from faucet.*

**CAUSE**—Low water level in tank; water lines are clogged; kink in water hose; air leak in suction line; dirty or hard-to-open inline check valve; defective pump check valve.

**PROBLEM**—*Pump cycles on and off although all faucets are closed.*

**CAUSE**—Water leak in plumbing; water leak in flush toilets; internal leak in pump; pump check valve not sealing.

**PROBLEM**—*Pump operates roughly and has excessive noise and vibration.*

CAUSE—Flow through intake line is restricted, kink in hose; pump mounted on flimsy board; deformed or ruptured pulsation dampener in pump; worn connecting rod bearing.

**PROBLEM**—*Pump fails to start when faucets are closed.*

CAUSE—Ice in pressure switch chamber; clogged piping; no voltage to pump; defective pressure switch.

**PROBLEM**—*Pump fails to start when faucets are closed.*

CAUSE—Empty water tank; insufficient voltage to pump motor; defective pressure switch.

### 32.3.1. Physical Protection of Water Lines:

Do not store heavy items such as canned goods, tools, etc., in areas where they may come in contact with water lines and electrical wires and cause damage due to road vibration.

### 32.3.2. Water Conservation:

The distance traveled may depend upon how long your water supply lasts. Use as little water as necessary for bathing and cooking. In vehicles with a shower, rinse yourself, then soap down and rinse again. With this technique, you will bathe with a minimum of water. In the kitchen, the wise traveler does not wash hands or dishes with running water. Instead draw enough water to complete the task.

### 32.3.3. Handling the Water Supply:

When you first bring your new vehicle home, you can be assured your dealer has tested the water tank for leaks as has the factory. However, it is advisable to flush the water tank before using. Use a standard garden hose to provide a connection to the outside water supply. We recommend 25 to 50 feet of non-toxic plastic water line. Ask your dealer about hoses, because some brands cause a bad taste in the water supply.

When filling your tank, be sure the water fill area is clean and free from dirt and debris. Clean your filling hose nozzle before inserting it into the water fill. Only refill the water tank at good water sources.

### 32.3.4. Sanitizing Potable Water Systems:

To assure complete sanitation of your potable water system it is recommended that the following procedures be followed on a new system, one that has not been used for a period of time, or one that may have become contaminated:

- Prepare a chlorine solution using one gallon of water and ¼ cup of household bleach (5% sodium hypochlorite solution). With tank empty, pour one gallon

of solution into the tank for each fifteen (15) gallons of tank capacity. NOTE: As an option, several commercial solutions are available and should be used as directed on the package.

- Complete filling of tank with fresh water. Operate all faucets to release trapped air.
- Wait at least three hours then drain and flush with potable water.
- To remove any excessive chlorine taste or odor which might remain, prepare a solution of one quart vinegar to five gallons water and allow this solution to set in tank for several days.
- Drain tank and flush with potable water.

### 32.3.5. Filling Water Supply Tank

- Sanitize according to previously stated method.
- Close drain valves on the supply tank and water heater and any low point drains in the water lines.
- **VERY IMPORTANT:** Before turning on the water pump, open kitchen and bathroom faucets. This will allow air to escape from the water lines and water heater while water is being pumped through the lines.
- Turn pump on and allow several seconds for the pump to prime itself.
- Wait for the water heater and water lines to fill. **THE WATER HEATER MUST NOT BE TURNED ON UNLESS IT IS FILLED WITH WATER.**
- When air ceases to bubble out of faucets, turn off faucets.
- Your water system is now ready for use.
- Refill your supply tank to replenish water used for filling the water heater and water lines.
- **BE SURE TO TURN OFF PUMP** when traveling or when your trailer not in use.

## **32.4. CITY WATER SYSTEM**

The city water system installed in all Sundowner trailers operates just like the water supply system in your home. Although this is traditionally referred to as a “city water” system, it will work equally well with private well systems.

Connect a clean water hose to the water service and the city water inlet fitting. We recommend allowing a small quantity of water to flow from the hose prior to hooking to the trailer inlet in case there is any dirt or other foreign matter in the hose. However, this should be done in a manner that will not create a muddy spot for you or your neighbors. After the hose is connected to the trailer, turn on the city water for water pressure throughout your trailer. Be sure to purge the system of trapped air before lighting the water heater.

*CAUTION:* Excessive pressures from water supply systems may be encountered in some parks, especially in mountain regions. Water pressure regulators are available to protect your system against such high pressure. A regulator of this type is recommended as a safety



precaution.

### 32.4.1 Draining the Fresh Water System:

The easiest way to winterize your water supply system is by using one of the many potable antifreeze solutions available through all R.V. supply houses and dealers for this purpose. Simply follow the directions provided with the antifreeze solution chosen.

Water system drains are provided on the trailer to allow draining of the water for sanitizing, storage or winterization (when you do not wish to use the potable antifreeze). The water heater has a separate drain built in. Refer to the water heater manufacturer's instruction for their recommendations regarding draining of the water heater.

After leveling the trailer, the fresh water system should be completely drained by opening all faucets and drain valves, including those on the water heater and water storage tank (if installed). The following procedure is recommended:

- a) If a water filter is installed, remove the filter cartridge and drain the lower portion of the housing.
- b) Because of the check valve built into the pump, blowing out the lines will not remove the water from your water system. Follow the steps below:
  - Drain the water tank through the drain on the tank. If the tank has no drain, open a faucet and allow the pump to pump the tank dry.
  - Drain the lines by opening the lowest outlet or drain in the system.
  - Remove the outlet line on the pump. Turn the pump on, allowing the pump to remove any remaining waters (probably about a cupful). A towel or rag can be used to catch this water.
  - Having removed the water from the system, reattach the pump hose. The system is now winterized. NOTE: It is much easier to winterize using one of the potable antifreeze solutions available from your dealer.
- c) As an added precaution, after water has quit draining and the valves and faucets are still open, you may wish to apply air pressure (service station air hose) to blow out any remaining water that may be trapped. Should you wish to blow the lines out with air, apply the air nozzle to the system where the outlet hose has been removed. Be sure all valves are open before applying air pressure or you may damage the water lines and the water heater.
- d) If an antifreeze solution is now added to the water system for more positive protection, be sure it is of a type approved for potable water systems. **DO NOT USE AUTOMOTIVE TYPE ANIFIREEZE; USE NON-TOXIC (POTABLE) ANTIFREEZE ONLY.**
- e) Leave all faucets and valves closed during storage. Before using your trailer again, be sure to sanitize the water system in accordance with the instructions above.

### ***32.4.2. Using the Water System During Freezing Weather:***

Please keep in mind that your vehicle was not designed for extended use during sub-freezing weather. If you wish to do so, refer to the cold weather camping information elsewhere in this manual and be certain to provide adequate protection for all plumbing, both water supply and drain lines.

## **33. SEWAGE AND WASTE SYSTEMS**

---

The waste system in your trailer consists of the stool, holding tanks and termination valve(s). Proper care and maintenance of your waste system will ensure many years of trouble free service.

Trailers equipped with holding tank waste systems make you independent of other restroom facilities during your travels. Depending on the size of your holding tanks, the size of water tank, and the amount of water used, you can stay away from service facilities for extended periods of time.

### **33.1 DRAIN OUTLET**

A label “DRAIN OUTLET” marks the drain outlet. It is engineered for a quick, detachable type hookup of either the dust cap with attached chain, or a drain hose adapter. Always secure the cap when traveling to prevent leakages. Law in many states requires this.

Simply attaching your drain hose to an appropriate sewer inlet and opening the termination valve(s) equips your trailer to be used for as long as you remain connected. However, if your trailer is equipped with holding tanks we recommend that you leave the termination valves closed until the holding tanks are nearly full and then emptying them. This helps keep solids from building up in your holding tanks.

### **33.2 SEWAGE DISPOSAL AND HOLDING TANK CLEANING**

You will find that several simple guidelines for holding tank care and cleaning will facilitate holding tank sewage system maintenance. Before starting on an extended trip, it is advisable to add 1 to 2 gallons of water to each holding tank. This prevents the buildup of solids in front of the termination valve. You may wish to also add one of the commercially available holding tank deodorants.

Use only toilet tissue in the stool, facial tissues or other paper will not dissolve in the liquid of the holding tank. Also, the toilet should be flushed clean after use. Any paper which sticks in the toilet valve will cause a steady trickle of water into the holding tank, which is a nuisance and depletes your water supply.

To determine when to empty the holding tank, find out how much water the stool uses per flush. Usually this is between 1 and 2 quarts of water. If you have a 20-gallon holding tank, this means you can get about 80 flushes before having to empty the holding tank. When it's time to empty, just take your trailer to the nearest dump station and hook up the sewage facilities. When connected to park sewage facilities, it is advisable to keep your termination valve closed until the tank is nearly full. This will help the solids dissolve and the tank will empty more completely.

After you have hooked up the sewer hose, unfasten the termination valve clips and pull the slide. It is advisable to flush the holding tank with water during the dumping procedure.

Close the slide after rinsing. Store the sewer hose in the receptacle provided for the purpose. To clean your holding tank, fill the holding tank about one-half full with water on your way home. After your arrive, empty the holding tank completely and rinse the water.

**NOTICE: UNDER NO CONDITION SHOULD THE CONTENTS OF THE TANK EVER BE EMPTIED BESIDE A ROADWAY, IN A RIVER OR STREAM, OR DIRECTLY UPON THE GROUND. DOING SO IS NOT ONLY DISCOURTEOUS, IT IS IN VIOLATION OF SEVERAL LAWS.**

Bacteriologists tell us that additives put into the sewage to increase bacterial action are not necessary because the proper bacteria are naturally present in the waste. The bacteria multiply so rapidly in the water, that there are sufficient numbers to break down the solids within a very short time. However, the storage period in the tank is too short for any practical digestion.

### **33.3 MARINE TOILET**

The toilet manufacturer has provided complete operating and maintenance instructions. These instructions have been provided with your trailer and should be read completely prior to the first use of the toilet.

There are certain items that should never be put into marine toilets. These include:

- Facial and other similar tissues—Unlike toilet paper, nearly all facial tissues are impregnated and treated to give them wet strength. This quality makes it almost impossible to dissolve them in the tank. Most toilet paper dissolves after a period of time, especially if agitated by traveling. However, facial and similar tissues do not, so never put them in the tank.
- Detergents and bleaches—This is a fairly common practice and always does more harm than good. The harm is that detergents remove lubrication oils and greases. They actually do no good at all.
- Antifreeze, ammonias, alcohols or acetones—Such liquids as these may damage your tank, valve parts, tank fittings or drain hose. They do no good and may cause a lot of trouble. Drain your tank when storing the coach to prevent freezing.

To winterize your toilet, follow the method described below:

Completely drain the toilet water supply line. Open the toilet valve and insert a piece of wood into the outlet located at the bottom of the bowl. Release the blade control slowly until the blade holds the object in place. This will hold the water control valve open and prevent any residue from being trapped there.

### **33.4 PREPARING DRAINAGE SYSTEM FOR STORAGE AND WINTERIZING**

The entire drainage system should be thoroughly drained and flushed with fresh water. The following procedures are recommended:

- Completely drain holding tank(s) of waste materials.
- Flush sinks, shower and lavatory with water, rinse well and allow to drain into tanks.
- Agitate water in holding tanks by driving vehicle for a few miles. Drain all tanks again.
- As an alternate to the above, use a chemical deodorant; let the mixture stand a few days and then drain.
- Flush with water and drain again.
- Fill traps and partially fill tanks with antifreeze approved for use in plastic pipes. Normally, a cupful of antifreeze poured into each drain will fill the trap. USE ONLY NON-TOXIC (POTABLE) ANTIFREEZE.

## **34. APPLIANCES**

---

Each appliance installed in your trailer has been supplied with an operations manual, maintenance instructions and warranty from the manufacturer of the appliance. We strongly recommend taking the time to study these manuals prior to using the appliances for the first time. Should you experience any difficulty with one of your appliances, warranty claims must be filed with the manufacturer of the appliance. Sundowner Trailers, Inc. is not authorized to resolve warranty problems with appliances.

### **34.1 FURNACE**

The furnace in your new trailer uses a forced air system. This is a completely sealed unit that draws in outside air for combustion and also delivers warm air to the interior of the trailer. A thermostat is located on a wall for easy heat control.

For additional information please see the manual supplied by the furnace manufacturer.

### **34.2 MICROWAVE (OPTIONAL IN SOME UNITS)**

Microwave cooking is especially convenient for use in your recreational vehicle. Not only is it convenient, but it also produces less heat than more conventional cooking methods—a much-appreciated benefit during warm weather camping.

General Microwave Care:

- Turn the oven off before cleaning.
- Keep the inside of the oven clean. When food splatters or spilled liquids adhere to oven walls, wipe with a damp cloth. Mild detergent may be used if the oven gets very dirty. The use of harsh detergents or abrasives is not recommended.
- The outside oven surface should be cleaned with soap and water, rinsed and dried with a soft cloth. To prevent damage to the operating parts inside the oven, water should not be allowed to seep into the ventilation openings.
- If the Control Panel becomes wet, clean with a soft, dry cloth. Do not use harsh detergent or abrasives on Control Panel. When cleaning the Control Panel, leave the oven door open to prevent oven from accidentally turning on. After cleaning, touch Cancel pad to clear display window.
- If steam accumulates inside of around the outside of the oven door, wipe with a soft cloth. This may occur when the microwave oven is operated under high humidity conditions and in no way indicates malfunction of the unit.

### **34.3 RANGE**

Any brushed chrome surface needs to be cleaned and polished as follows:

- Clean the chrome with a mild soap and water, wipe dry with a soft cloth and apply

## Appliances

---

a light coat of oil such as “Johnson’s Baby Oil” periodically.

- After each use, light splattering or fingerprints can easily be wiped off with a paper towel.

The products of combustion from the top burner pilots will cause red deposits to build up on the underside of the top. This will NOT affect the the top. However, if you wish to prevent it, keep the underside of the top regularly coated with baby oil and wipe the deposit off regularly as it appears. DO NOT use steel wool, ammonia, acids or abrasives on finished chrome surfaces.

Normal cooking vapors will condense on the vent and backguard leaving a brownish deposit. This should be cleaned of with soap and water after each use. If the deposits are allowed to accumulate, a hard stain will develop which will be difficult to remove and may damage the finish.

The range in your new Sundowner trailer has to be installed to help make the use of your Sundowner trailer more enjoyable. This appliance works on L.P. Gas and should never be connected to a natural gas source. To operate the range, push in the desired burner knob and turn. At the same time, hold a match next to the burner. If there is air in the gas line, it may take a few seconds to light.

*NOTE: A window or air vent should be open slightly while using the range. Gas flames consumes oxygen that has to be replaced to assure proper combustion.*

### **34.4 REFRIGERATOR**

If you have an optional refrigerator designed to operate on either electricity or L.P. Gas, you should study the manufacturer’s operating instructions carefully prior to use.

### **34.5 WATER HEATER**

If hot water is used with discretion, there is always an ample supply. With controls similar to those on your home water heaters, L.P. Gas is automatically supplied to heat water to desired temperatures and then automatically shut off, leaving the pilot burning. A regulated mixture of gas and air is ignited by the pilot light to provide a flame directed into the heating tube. The heating assembly is sealed off from the Sundowner trailer interior and vented to the outside atmosphere.

If the gas supply to the heater is cut off for any reason or if the pilot is blown out, the gas supply is automatically cut off and controls will have to be reset to obtain pilot lighting.

## **35. VEHICLE CARE & GENERAL MAINTENANCE**

### **35.1 PREVENTATIVE MAINTENANCE GUIDE**

Your Sundowner trailer conversion will give you many years of dependable service with proper maintenance and care. Following proper procedures when setting up your new trailer, combined with periodic maintenance of the interior and exterior, will help ensure trouble-free use. Keeping your trailer in peak condition requires a minimum of effort if done consistently. If your trailer is neglected, serious problems may go unnoticed until they become unsafe or dangerous.

### **35.2 ROOF VENTS**

Roof vent screens should be inspected occasionally to prevent buildup of dirt and debris that could hinder openings. Each vent should be lubricated periodically to keep it in good working order. Never force open a roof vent.

Make sure roof vents are closed while you are on the highway because dust and dirt may enter the Sundowner trailer through the vent. This also prevents damaging the vents when passing under low objects such as roof overhangs or trees.

Power vent screens should be removed and cleaned to insure proper ventilation and to avoid the buildup of dust, which can affect the life of the motor in power vents.

### **35.3 WINDOWS**

There are several types of windows installed in Sundowner trailers. Each type of window has been selected to give the best design, appearance and ventilation for the vehicle in which it is installed.

Positive-seal jalousie type windows protect against the water and provide maximum ventilation. These windows operate easily if lubricated occasionally. If they bind, check for obstructions and setup. The windows may bind if the trailer is not level.

Sliding windows should also be lubricated occasionally to provide smooth opening and closing. Silicone lubricants provide proper lubrication without attracting dirt and other debris.

### **35.4 FLOORS**

High quality plywood floors are used in your Sundowner trailer. Some adjustment in the floor of your trailer may occur due to condensation, thermal expansion and settling of the wood after blocking at the campsite. Seasonal changes may also result in a certain amount of expansion and contraction of the wood. Keeping humidity down inside the unit and checking the level of your trailer after blocking can avoid floor problems. If you remain in one location for an extended period of time, the blocking should be adjusted after each seasonal



weather change to assure the trailer remains level.

### **35.5 EXTERIOR MAINTENANCE**

The exterior surface of your trailer is mill or enamel finished aluminum or, on some trailers, painted steel. To ensure lasting beauty of the exterior finish, it should be cleaned and waxed at least once a year. Wax should be applied to the aluminum trim or windows, vents and corners to protect against oxidation.

If you travel on roads where salt or chlorides have been used, wash off the travel dirt as soon as possible with warm water and a mild detergent. Also, if visiting the seashore, salt air will deposit salt crystals on your trailer. These crystals should be washed off as soon as possible. Removing salt crystals as soon as possible is particularly important for maintaining the finish on mill finished (natural) aluminum trailers.

Never use gasoline, naphtha or paint thinners to remove tar. These chemicals could cause the finish to soften and blister.

Check all metal screws for tightness at least twice a year; temperature changes may loosen the screws or the screws may work loose from road vibration. When tightening, make sure the screw is tight, without buckling the metal.

Check the caulking on the corners of the trailer and on the windows at least once a year. Extreme temperatures may tend to dry out the caulking compound and create the possibility of water leaks. Caulking should be inspected periodically and, if needed, the unit should be re-caulked before damage can occur. Make sure that window openers and vents are free of dirt and operate smoothly. It is also advisable to clean the windowsills and vents. The corners of the windows should be caulked annually with a window sealant available from your dealer.

Graphite powder on the door lock will keep it working freely.

Gas lines should be checked with air or soap solution for possible leaks. The gas refrigerator burner should be removed, cleaned and replaced in the spring because spiders and insects may form nests in the burner during the fall. All electrical connectors should be periodically inspected. Also check all wiring circuits for proper operation.

### **35.6 TIRES**

To get the maximum performance from your tires, check the air pressure often but only when the tires are cool. Never bleed out air immediately after driving. Recommended tire pressures vary with models, tire type and size. For specific pressures refer to the Federal Certification Label on your Sundowner trailer.

In a warm climate, park your trailer out of the sun whenever possible. In desert regions use tire covers to prevent ultraviolet deterioration to tires.

### **35.7 RAIN WATER LEAKS**

Water leaks into the coach should be repaired promptly. The water will lie inside the wooden interior of the trailer and will eventually cause wet rot. Never ignore a water leak.

### **35.8 ROOF**

The roof of your trailer is a one-piece aluminum roof or, on steel trailers, steel.

Your aluminum roof needs little or no maintenance. Inspect the seams periodically for hardening or deterioration of sealants. Re-coat the seams with a silicone sealant as needed—perhaps once each year.

Steel roofs should be inspected frequently (at least twice a year) and kept sealed with a high quality roof coating. Your dealer can advise you on the best available product for sealing the roof in your area.

## **36. APPEARANCE CARE**

---

---

### **36.1 CARE AND CLEANING OF INTERIOR**

**IMPORTANT:** Be sure your trailer is well ventilated while using any cleaning agents. Follow manufacturer's recommendations in using such products.

With the advent of modern materials composed of synthetic plastics and/or man made fibers, it is extremely important proper cleaning techniques and cleaners be used when cleaning. Failure to do this on the first cleaning may result in water spots, spot rings, setting of stains or soilage, all of which make it more difficult or impossible to remove in a second cleaning.

Dust and loose dirt that accumulates should be removed frequently with a vacuum cleaner, whiskbroom or soft brush. Normal soilage, spots or stains can be cleaner with the appropriate cleaning solutions. Never use gasoline, nail polish remover or acetone, lacquer thinners, bleaches, etc. Some basic steps should be remembered before cleaning is attempted:

- Remove stains as quickly as possible before they become "set".
- Use a clean cloth or sponge and change to a clean area frequently. (A SOFT brush may be used if stains persist).
- Use solvent type cleaners in a well-ventilated area; also do not saturate the stained area.
- If a ring should form after spot cleaning, the entire area should be cleaned IMMEDIATELY.
- Follow instructions on the label of the cleaner.

**CAUTION:** Many cleaners may be toxic or flammable, and their improper use may cause personal injury or may cause damage. Therefore, when cleaning, do not use volatile cleaning solvents such as: acetone, lacquer thinners, enamel reducers, nail polish removers, or such cleaning materials as laundry soaps, bleaches or reducing agents (except as noted in the fabric cleaning instructions on stain removal). Never use carbon tetrachloride, gasoline or naphtha for any cleaning purpose.

### **36.2 CLEANING GENERAL SOILAGE OR WATER SPOTS FROM FABRIC**

Vacuum area thoroughly to remove excess loose dirt. ALWAYS clean a complete section—mask adjacent areas along stitch or weld lines. Prepare cleaning agent in strict accordance with directions on label of container. Use suds only on a clean sponge or soft bristle brush—DO NOT wet fabric excessively or rub harshly with brush. Immediately after cleaning, wipe off any cleaner residue with a slightly damp absorbent towel or cloth.

**IMPORTANT—**Immediately after wiping, force-dry fabric with air hose, heat dryer or heat lamp. (Use caution with heat dryer or heat lamp to prevent damage to fabric). When materials with a sheen or luster finish are dry, wipe fabric lightly with a soft, dry clean cloth to restore sheen or luster.

### **36.3 SPOT CLEANING FABRIC MATERIALS WITH SOLVENT TYPE CLEANER**

Before attempting to remove spots or stains from fabric, determine as accurately as possible the nature and age of the spot or stain. Some spots or stains can be removed satisfactorily with water or mild soap solution (refer to accompanying “Removal of Specific Stains”). For best results, spots or stains should be removed as soon as possible.

Some types of stains or soilage such as lipstick, some ink, certain types of grease, etc., are extremely difficult and, in some cases, impossible to completely remove. When cleaning this type of stain or soilage, care must be taken not to enlarge the soiled area. It is sometimes more desirable to have a small stain than an enlarged stain as a result of careless cleaning.

Excess stain should be gently scraped off with a clean, DULL knife or scraper. USE VERY LITTLE CLEANER, light pressure and clean cloths (preferably cheese cloth). Cleaning action should be from outside the stain FEATHERING towards the center of stain and constantly changing to a clean section of cloth. When stain is cleaned from fabric, immediately dry area with an air hose, heat dryer or heat lamp to help prevent a cleaning ring (use caution with heat dryers or heat lamps to prevent damage to fabric material). If a ring forms, immediately repeat the cleaning operation over a slightly larger area with special emphasis on FEATHERING towards center of area. If ring still persists, mark off adjacent sections and clean entire affected panel section as previously described under “cleaning general soilage or water spots with foam type cleaner.”

### **36.4 REMOVAL OF SPECIFIC STAINS**

#### **36.4.1. Grease or Oil Stains**

Includes grease, oil, butter, margarine, shoe polish, coffee with cream, chewing gum, cosmetic creams, vegetable oils, wax, crayon, tar and asphalts. Carefully scrape off excess stain; then use fabric cleaner (solvent type) as previously described. Shoe polish, wax crayons, tar and asphalts will stain if allowed to remain; they should be removed as soon as possible—use caution as cleaner will dissolve them and may cause them to bleed.

#### **36.4.2. Non-Greasy Stains**

Includes catsup, coffee (black), egg, fruit, fruit juices, milk, soft drinks, wine, vomit and blood. Carefully scrape off excess stain; then sponge stain with cool water. If stain remains, use foam type cleaner as previously described. If odor persists after cleaning vomit or urine, treat area with a water/baking soda solution (1 teaspoon baking soda to 1 cup of warm water). Finally, if necessary, clean lightly with fabric cleaner (solvent type).

### **36.5 CLEANING VINYL OR LEATHER**

Ordinary soilage can be removed from vinyl or leather with warm water and a mild soap such as saddle soap or oil soap, or approved equivalent. Apply a small amount of soap solution and allow soaking for a few minutes to loosen dirt; then, rub briskly with a clean, damp cloth to remove dirt and soap residues. This operation may be repeated several times if necessary. Some soilage such as tars, asphalts, shoe polish, etc., will stain if allowed to remain—they should be wiped off as quickly as possible and the area cleaned with a clean dampened with cloth vinyl cleaner (solvent type). Do not use dry cleaning solutions.

### **36.6 GLASS SURFACE**

Glass surfaces should be cleaned on a periodic basis for continued good visibility. Use of a commercial household glass-cleaning agent containing ammonia will remove normal tobacco smoke and dust films sometimes caused by ingredients used in vinyls, plastics or other interior materials.

*NOTICE: Never use abrasive cleaners on any vehicle glass, as it may cause scratches.*

**WARNING!** Some windows are glazed with plastic rather than glass. NEVER use ammonia or products containing ammonia on plastic glazed windows. A cleaning wax designed for plastic product will do a good job of cleaning such glazing.

### **36.7 COUNTERTOPS, SIDEWALLS, DINETTES AND BATHS**

High pressure laminated countertops, dinettes, and vinyl sidewalls and baths may be cleaned with detergent and water, or liquid cleaners. These easy-to-clean surfaces may also be polished with furniture polish.

### **36.8 INTERIOR FIBERGLASS**

Interior fiberglass and other plastic parts should be cleaned with soap and water; avoid the use of abrasive or chemical cleaners. This includes fiberglass bathtubs, shower stalls and lavatories. These surfaces can be wiped clean with a damp cloth. Lubricate the holding tank latches and the slide lever using only recommended lubricants. The wrong lubricant may attack plastic parts and the rubber gasket.

### **36.9 VINYL FLOOR COVERING**

High-grade vinyl floor coverings are used in some models. These vinyl surfaces should be cleaned regularly to prevent sand, dirt, or small chips from grinding into the finish of the floor. When cleaning, a minimum of water should be used. Never let water stand on the floor. After cleaning, a protective covering of floor wax should be applied.

### **36.10 CARPETING**

Use normal carpet cleaning methods as you would in your home.

### **36.11 CABINERY**

Natural wood cabinets and wardrobes should be cared for like fine furniture. Application of furniture polish and cleaner will keep these woods surfaces beautiful. Avoid harsh polishes or waxes.

### **36.12 INTERIOR LUBRICATION**

Several interior features in your trailer may require periodic lubrication. Check the closet door hinges and drawers for binding. Silicone lubricants will free the latches and hinges if they are binding. Occasionally, rubbing drawer edges with candle wax or paraffin will help keep them sliding smoothly.

### **36.13 PANELING**

The wall paneling in your new trailer is a vinyl covered wood panel. If scratches occur, cover them by using a thin film of shoe polish or stain, followed by a coating of furniture wax. Your dealer or a local hardware store should carry putty sticks in colors that match your wall covings.

To clean, use a mild solution of soap and lukewarm water with a soft sponge or cloth. Refrain from the use of abrasive cleaners. They could cause the vinyl to scratch and turn dull. Grease spots and stubborn dirt can be cleaned off with all-purpose spray cleaner.

### **36.14 CUSHION COVERS**

**CAUTION: DO NOT DRY CLEAN.** If the cushions are dry cleaned, the vinyl on the reverse side of the cushion will shrink, become hard and cracked. Also, dry cleaning will remove the stain protection that may have been added in treating the fabric to retard against stains that may occur in usage.

**DO NOT REMOVE COVERS FOR CLEANING REASONS.** If covers are removed it may be difficult to reinstall covers due to possible shrinkage.

To clean cushion and bed mat covers, we recommend frequent vacuuming or light brushing to remove dust and grime and to prevent overall soiling.

### **36.15 CONDENSATION**

Some condensation of water vapor may temporarily occur in your trailer. This condensation results from moisture in construction materials that must work its way out of the wood and fiber. Also, during summer months, your Sundowner trailer may absorb moisture from the outside air.

You will notice moisture in the Sundowner trailer first on the windows. This indicates the humidity inside is too high. It is important to ventilate so evaporation of the enclosed moisture can occur.

Cooking, bathing, laundering and breathing all create moisture. Control of this moisture is essential for proper maintenance of your Sundowner trailer. Exhaust fans and vents for gas burners tend to alleviate this problem. There are several steps one can take to reduce moisture problems inside your Sundowner trailer.

- Use the vent fan when cooking.
- Close the bathroom door and open the bathroom vent or window during and after showering.
- Keep one or more vents slightly open.

Refer to the section on Winter Camping for further information regarding condensation.

### **36.16 STORAGE IN FREEZING CONDITIONS**

#### **36.16.1 Waste System**

1. Flush toilet until internal water drains. Block the water valve open with a suitable object such as a wad of paper. Refer to instructions supplied by the toilet manufacturer.
2. Drain holding tank. Refer to waste system. Close drain valve.
3. Thoroughly clean and drain the holding tank(s). Many chemicals on the market will make the job easier.

#### **36.16.2 Fresh Water System (Method 1)**

1. Add non-toxic antifreeze to the water storage tank. Refer to instructions with antifreeze.
2. Open low-point drains.
3. Turn water pump switch on. Allow pump to operate for a couple of minutes then turn switch off.
4. Leave all drains open.

### 36.16.3 Fresh Water Systems (Method 2)

1. Add non-toxic antifreeze to the water storage tank. Refer to instructions with antifreeze
2. Turn water pump switch on. Open all faucets, drains, shower heads and water heater drain to allow antifreeze to circulate throughout. Close each item.
3. Pour a cup full of approved plastic ABS pipe antifreeze into each drain opening to prevent freezing of tape.
4. Before restoring system to use, drain and sanitize the system. Refer to fresh water system and instructions provided with the antifreeze product.

### 36.16.4 Storage Tips in General

1. Close L.P. Gas tank outlet valve.
2. Turn furnace thermostat off.
3. Turn all electrical components off.
4. Defrost and clean refrigerator. Leave door slightly open.
5. Clean entire coach with particular attention to food and odor causing items.
6. Close all windows and vents.
7. Seal vent openings to prevent birds and insects from nesting in camper and put on cover for roof air conditioner.
8. Drain holding tanks. Fill tanks with water and add one cleaning enzyme pellet for each seven gallons of water. If possible, allow to stand for four days. Drain holding tanks and leave valves open.
9. Batteries will discharge themselves in 30-45 days. Keep batteries fully charged to insure long life and dependable service. If possible, store batteries in a warm, dry place.
10. Drain fresh water system.
11. Operate automatic air conditioner five minutes each week to keep compressor lubricated.